



WHAT'S NEW in 2018



Live Edge Slabs

Live Edge Slabs are the natural cut of wood that keeps the unique lines of the tree along one or two of its edges. We are currently stocking live edge slabs and are continually looking for other sizes and species to bring in. All slabs are unfinished.



Mantels

Whether your home is rustic, classic, contemporary or unique in some other way, St. Charles Hardwoods can custom make your **Mantel** to fit your needs. We do stock several mantels in our store, so come on in for your next mantel.



Butcher Block Counter Tops

Butcher Block Counter Tops can be a wonderful feature in your kitchen as well as add warmth, beauty and elegance to your home. Ask an associate for details.

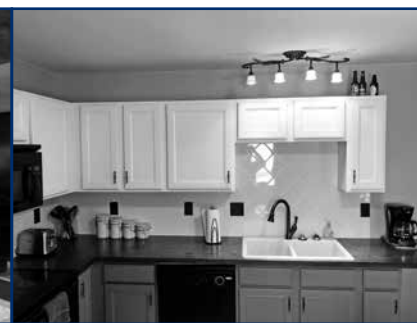
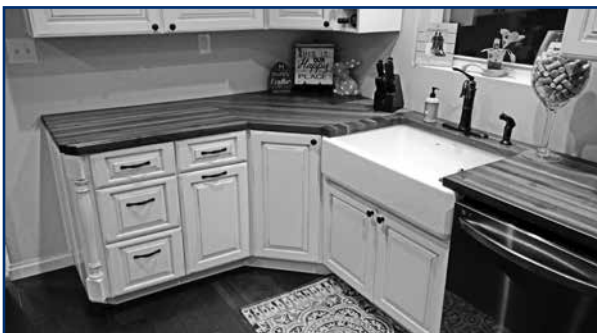



CONTENTS

General Information	2	Shelf Brackets	38
About Us	3	Mantels	39
How To Contact Us	3	Wood Flooring	40
Mill Services	4	Wood Floor Registers	40
Architectural Moulding	4	Wood Flooring Installation Tips	41
Product Sponsors	Inside Back Cover	FJ Primed Poplar	
<hr/>			
Bar Railing & Accessories	5-6	Crown	42
Fluted Casing	7	Casing	43
Butterfly Casing	8	Base	44
2 & 3 Line Casing	9	FJ Primed Pine	
Casing	10	Base Shoe/Base	45
Stop	11	Casing	45
Mullion	11	Quarter Round	46
Base Moulding	12-13	Chair Rail	46
Crown Moulding	14-18	Crown	46
Crown Blocks	19	Solid Pine	
Dentil & Rope Moulding	20	Base Shoe/Base	47
Flooring Accessories	21-23	Casing	47
Chair Rails	24-25	Chair Rail	48
Panel Moulding	26-27	Moulding	48
Picture Frames & Cabinet Parts	28	Crown	48
Cap Mould	29	Dowel Rods	49
Screen Mould	29	Hardwood S4S Lumber	49
Outside Corner Mould	30	S3S Lumber	50
Quarter Round	30	Hardwood Plywood	51
Cove Mould	31	TruStile® Interior Doors	52
Brick Mould	31	Radius Millwork	53
Half Round	32	W.M. Coffman® Stair Parts	54
Mantel Mould	33	Ultra-Flex® & Flex Trim™ Moulding	55-56
Tongue & Groove Paneling	34	Architectural Columns	57
Jams & Sills	35	Corbels & Bar Brackets	58-61
Stair Parts	35	Appliqués	62-65
Plinth Blocks	36	Brass/Stainless Bar Fittings	66
Rosettes	37	Butcher Blocks	67
		Customize It!	68-69

St. Charles Hardwoods began serving the St. Louis area with quality hardwood products in 1988. Our knowledge of hardwood products is outstanding. We are known as the woodworkers' source for hardwood lumber, hardwood plywood, hardwood flooring and architectural mouldings. We also carry many different items such as: TruStile® interior doors, WM Coffman® stair parts, Ultra-Flex® mouldings, custom radius millwork and brass bar fixtures. St. Charles Hardwoods is widely know as the complete woodworkers' store.

GENERAL INFORMATION

STOCK MOULDING PROFILES

All mouldings shown in this catalog are stocked in poplar and red oak. Many items are also stocked in birch, cherry, pine and walnut.

RANDOM LENGTHS

All hard wood species are supplied in random lengths between 3' thru 16', depending on the item.

SPECIFIED LENGTHS

Specified lengths are available for an additional up-charge. These up-charges can vary depending on the item. When specified lengths are ordered we have the option to ship a combination of length to achieve the lengths ordered, but you will not be invoiced for more than 10% over shipment. Specified 16' lengths are subject to availability.

CUSTOM MOULDINGS

When requesting a quote on a custom moulding for which we do not have a knife, we need a dimensioned drawing or sample, along with the quantity and species required. Set up charges and knife grind charges may apply depending on the quantity.

Depending on the quantity, a set up charge may apply. When we run custom orders, a 10% overage occurs at times. Please take this into consideration when placing an order on custom runs.

All custom orders may require a deposit of one half down, when the order is placed.

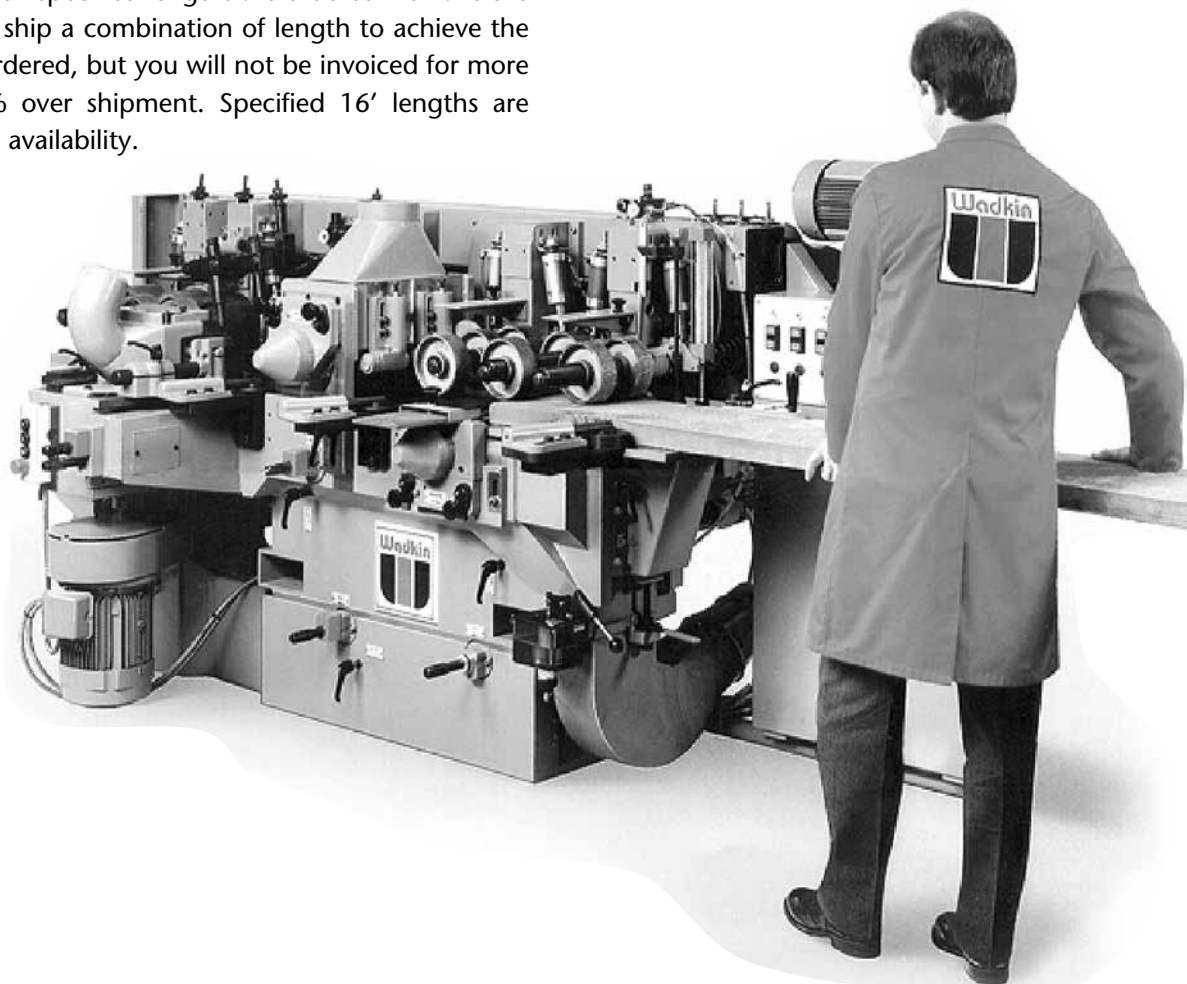



ABOUT US

This is truly one of those American success stories. In 1988, Eddie and Jayne Wilson decided to take a small savings and buy some lumber and a truck of their own and began their career in wood. Eddie started by driving trucks and delivering lumber by himself, along with Jayne helping in the office with sales and accounting. Soon they were serving the St. Louis metro area with hardwoods and hardwood plywood. For some time Eddie and Jayne answered phones, filled and delivered orders and the rest is history. Soon Eddie and Jayne were staffing the company with other quality people, bringing outstanding knowledge and service that has brought unprecedented growth to St. Charles Hardwoods.

St. Charles Hardwoods is located at 3909 Mid Rivers Drive in St. Peters, Missouri. In 1996, St. Charles Hardwoods purchased and continues to own their mill in Bowling Green, Missouri, where they mill over

200 stock profiles and unlimited custom profiles of architectural mouldings in any species of wood.

St. Charles Hardwoods offers 16 species of domestic lumber and 22 species of exotic lumber; they are more than a lumber store. From the fine woodworker, to the furniture builder, to the cabinetmaker, to the homebuilder, St. Charles Hardwoods is the woodworkers' choice. When books, instruction videos, or advice are needed, St. Charles Hardwoods is well equipped with resources. Their staff is comprised of experienced people from several fields of woodworking. The atmosphere of their store is pleasing, so be sure to go in soon. It is the complete woodworkers' source in the area.

Thank you.

All of the staff at St. Charles Hardwoods

HOW TO CONTACT US:

St. Charles Hardwoods

3909 Mid Rivers Mall Dr. • St. Peters, Mo 63376

Phone: (636) 926.2000 • Fax: (636) 926.8080

Email: stch@stcharleshardwoods.com • Web Site: stcharleshardwoods.com



@ St. Charles Hardwoods





MILL SERVICES

BECAUSE WE OWN OUR OWN MILL,
WE CAN SERVE YOU BETTER!

St. Charles Hardwoods' mill is located approximately 50 miles away from our St. Peters, Missouri location, in Bowling Green, Missouri. Sitting on over 20 acres, our mill provides us with many different ways we can accommodate your specific needs. Our mill provides all of our architectural mouldings and S4S material that we stock at our store.

Our mill has over 300,000 board feet of stocked lumber ready for use at any time. We have five moulders that run non-stop to keep up with production. We have our own knife grinding shop, allowing us to produce any custom knife for your specific need. We have a special moulder that produces any custom radius arches. We also have a glue-clamping machine to produce beautiful butcher-block tops.



ARCHITECTURAL MOULDING

From traditional base and casing to custom architectural profiles, we are capable of producing moulding in almost any hardwood or softwood species you may require.



CUSTOM PLANING • CUT COMPONENT PARTS • GLUING UP • SANDING
S4S • RADIUS MOULDINGS • BUTCHER BLOCK TOPS

BAR RAILING & ACCESSORIES

STOCKED PROFILES

*Our mouldings are stocked in Poplar & Red Oak.
Some items are stocked in Birch, Cherry, Walnut, Hard Maple & Pine.*

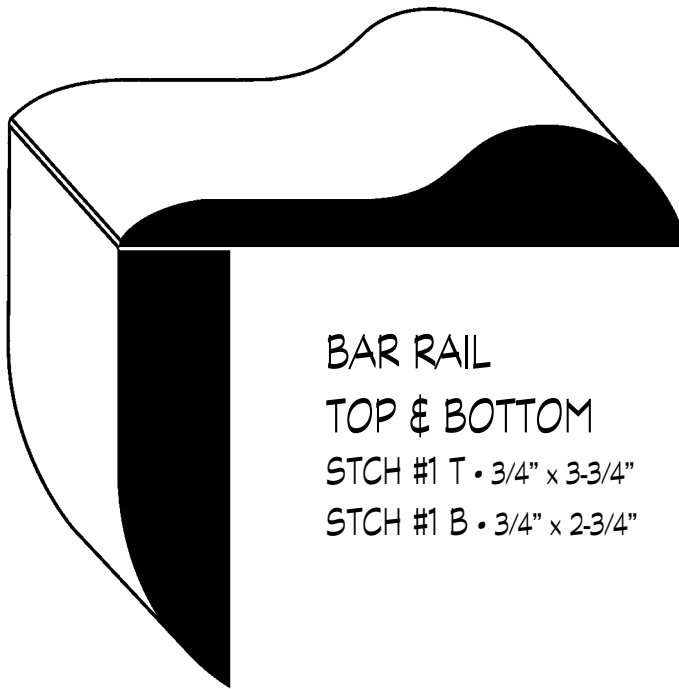

BAR RAIL
TOP & BOTTOM
STCH #1 T • 3/4" x 3-3/4"
STCH #1 B • 3/4" x 2-3/4"

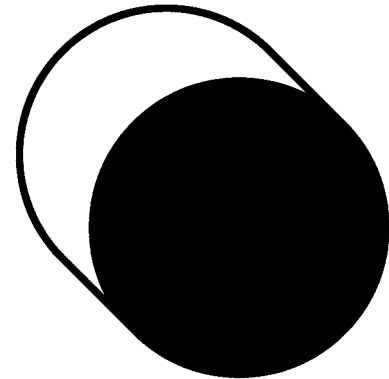

FOOT RAIL
SCD-2 • 2"
2RC • 2"

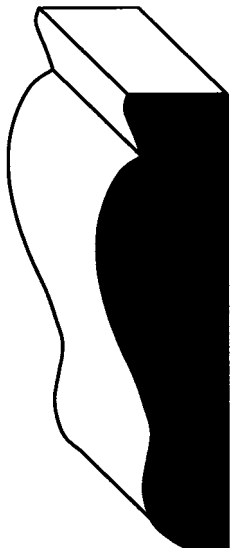

BAR RAIL BOTTOM
STCH #1 C • 3/4" x 2-3/4"

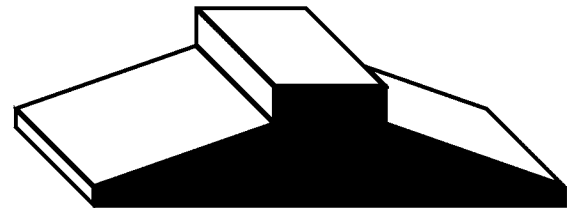

GLASS RAIL
STCH #4 • 3/4" x 3"



GLASS RAIL
STCH #218 • 1/2" x 1-5/16"

All items priced per lineal foot • Specific lengths — add 15% • Specified 16' — add 25%



BAR RAILING & ACCESSORIES

STOCKED PROFILES

*Our mouldings are stocked in Poplar & Red Oak.
Some items are stocked in Birch, Cherry, Walnut, Hard Maple & Pine.*



BAR RAIL
STCH #2 • 1-1/4" x 5-1/2"



BAR RAIL
STCH #179
1-1/2" x 2-5/16"

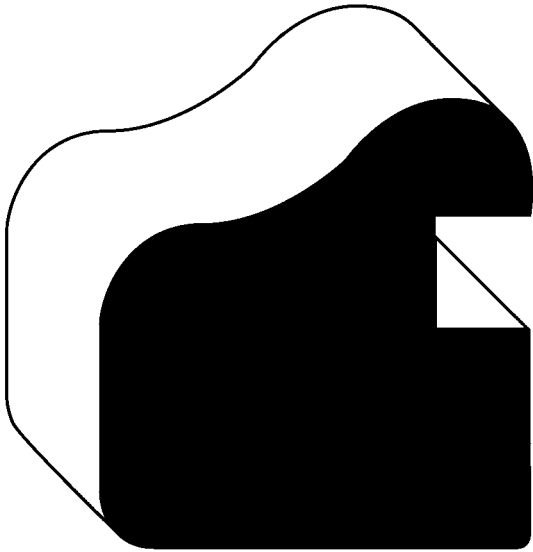

BAR RAIL
STCH #3 • 3-3/8" x 3-1/2"

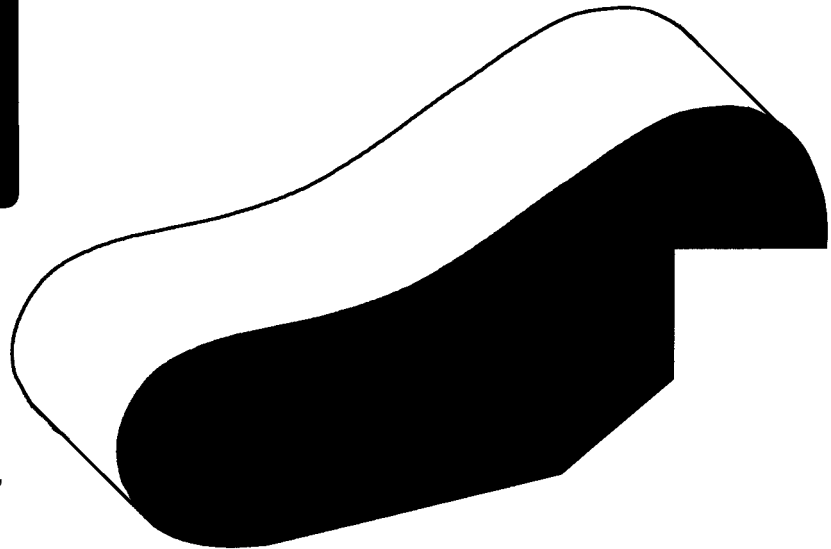

BAR RAIL
STCH #199 • 1-3/4" x 4-1/2"

FLUTED CASING

STOCKED PROFILES

*Our mouldings are stocked in Poplar & Red Oak.
Some items are stocked in Birch, Cherry, Walnut, Hard Maple & Pine.*



STCH #5 • 11/16" x 5-1/4"



STCH #6 • 11/16" x 4-1/4"

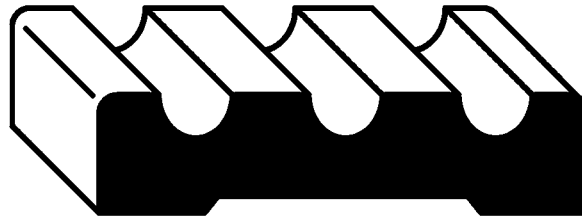

STCH #7 • 11/16" x 3-1/4"

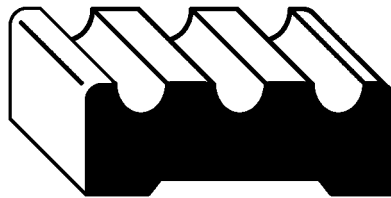

STCH #8 • 11/16" x 2-1/4"

All items priced per lineal foot • Specific lengths — add 15% • Specified 16' — add 25%

BUTTERFLY CASING

STOCKED PROFILES

*Our mouldings are stocked in Poplar & Red Oak.
Some items are stocked in Birch, Cherry, Walnut, Hard Maple & Pine.*



STCH #9 • 11/16" x 2-1/4"

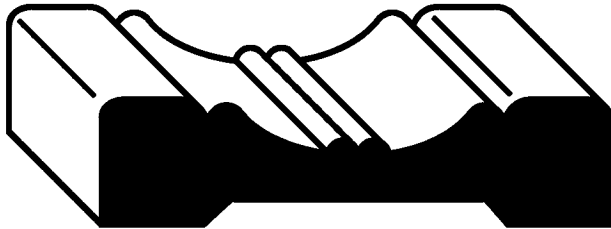

STCH #10 • 11/16" x 3-1/4"



STCH #11 • 11/16" x 4-1/4"



STCH #12 • 11/16" x 5-1/4"

All items priced per lineal foot • Specific lengths — add 15% • Specified 16' — add 25%

LINE CASING

STOCKED PROFILES

*Our mouldings are stocked in Poplar & Red Oak.
Some items are stocked in Birch, Cherry, Walnut, Hard Maple & Pine.*

THREE LINE

STCH #13 • 11/16" x 2-1/4"

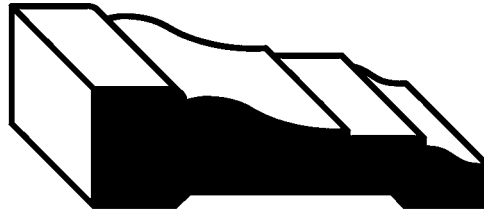

TWO LINE

STCH #14 • 3/4" x 2-1/4"

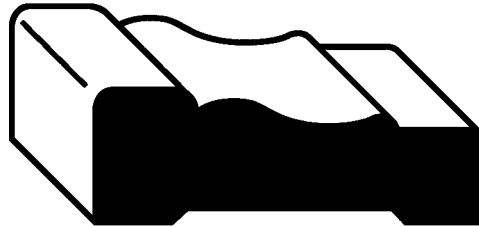

THREE LINE

STCH #15 • 11/16" x 3-1/4"

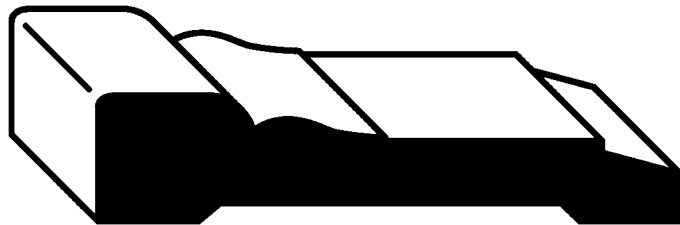

TWO LINE

STCH #16 • 11/16" x 3-1/4"



STCH #726 • 1-1/16" x 3-1/2"

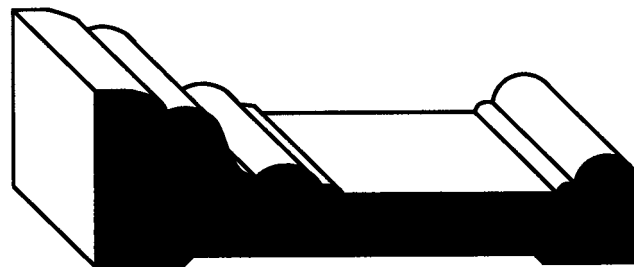

All items priced per lineal foot • Specific lengths — add 15% • Specified 16' — add 25%

CASING

STOCKED PROFILES

*Our mouldings are stocked in Poplar & Red Oak.
Some items are stocked in Birch, Cherry, Walnut, Hard Maple & Pine.*



STCH #127 • 1/2" x 2-1/4"

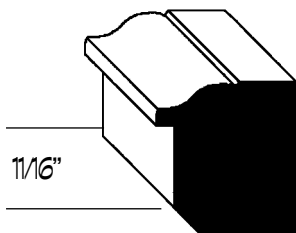

CASING EXTENSION
STCH #170 • 1" x 1-1/16"



STCH #132
1-1/16" x 4-1/2"

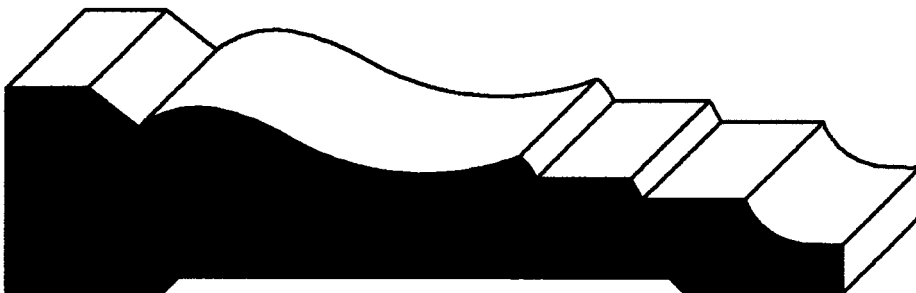

STCH #133
1-1/4" x 5-3/8"

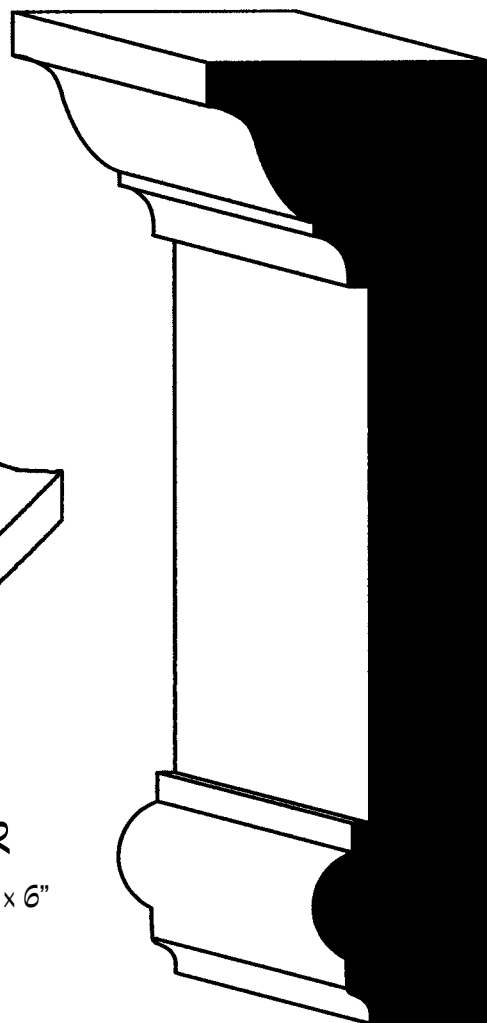

DOOR HEADER
STCH #222 • 1-3/4" x 6"

All items priced per lineal foot • Specific lengths — add 15% • Specified 16' — add 25%

STOP

STOCKED PROFILES

*Our mouldings are stocked in Poplar & Red Oak.
Some items are stocked in Birch, Cherry, Walnut, Hard Maple & Pine.*



STCH #17 • 15/32" x 1-1/4"



STCH #18 • 3/8" x 1-3/8"



STCH #191 • 7/16" x 1-1/4"



STCH #192 • 7/16" x 1-1/8"

MULLION

STOCKED PROFILES

*Our mouldings are stocked in Poplar & Red Oak.
Some items are stocked in Birch, Cherry, Walnut, Hard Maple & Pine.*



STCH #19 • 3/8" x 1-3/4"



STCH #20 • 3/8" x 1-3/8"



STCH #21 • 5/8" x 3-5/8"



STCH #22 • 1/4" x 1-1/4"



STCH #23 • 1/4" x 1-1/2"

All items priced per lineal foot • Specific lengths — add 15% • Specified 16' — add 25%

BASE MOULDINGS

STOCKED PROFILES

*Our mouldings are stocked in Poplar & Red Oak.
Some items are stocked in Birch, Cherry, Walnut, Hard Maple & Pine.*



STCH #24 • 5/8" x 2-1/4"
 STCH #25 • 5/8" x 4-1/4"
 STCH #25-5 • 5/8" x 5-1/4"
 STCH #26 • 5/8" x 3-1/4"

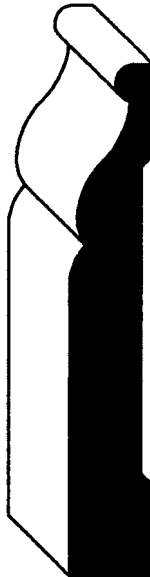

STCH #27 • 5/8" x 4-1/4"
 STCH #27-5 • 5/8" x 5-1/4"
 STCH #28 • 5/8" x 3-1/4"



STCH #126 • 5/16" x 3"

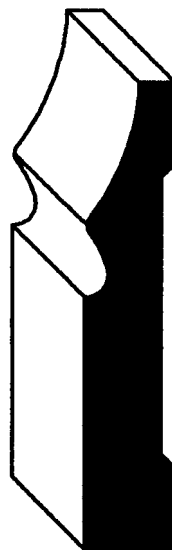

STCH #29 • 5/8" x 3-1/4"
 STCH #30 • 5/8" x 4-1/4"

All items priced per lineal foot • Specific lengths — add 15% • Specified 16' — add 25%

MOULDINGS

STOCKED PROFILES

*Our mouldings are stocked in Poplar & Red Oak.
Some items are stocked in Birch, Cherry, Walnut, Hard Maple & Pine.*

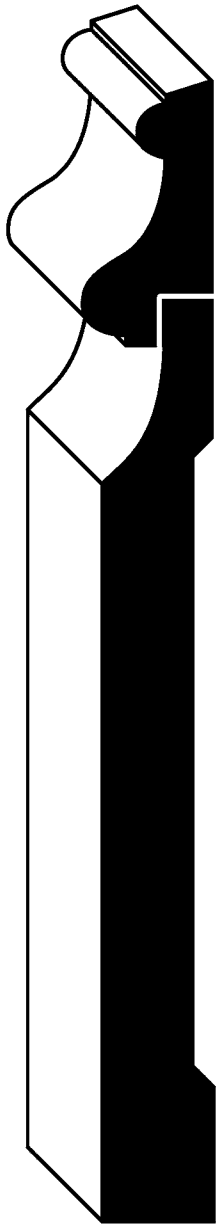

TOP MOULD
STCH #68 • 1-1/16" x 1-1/2"

BOTTOM MOULD
STCH #31 • 5/8" x 4-1/4"
STCH #32 • 5/8" x 5"

OVERALL • 6-5/16"

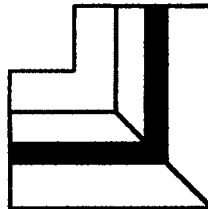

**OUTSIDE
CORNER**
STCH #158
7/8" x 1-1/4" x 8"

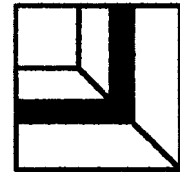
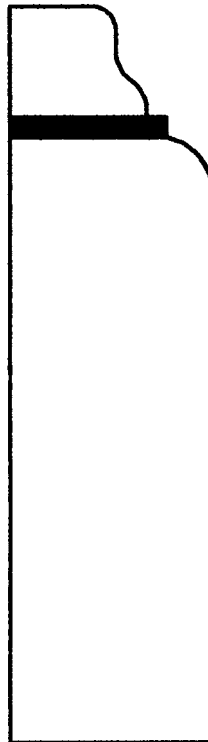
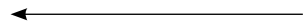

**INSIDE
CORNER**
STCH #159
7/8" x 7/8" x 8"



All items priced per lineal foot • Specific lengths — add 15% • Specified 16' — add 25%

CROWN MOULDINGS

STOCKED PROFILES

*Our mouldings are stocked in Poplar & Red Oak.
Some items are stocked in Birch, Cherry, Walnut, Hard Maple & Pine.*

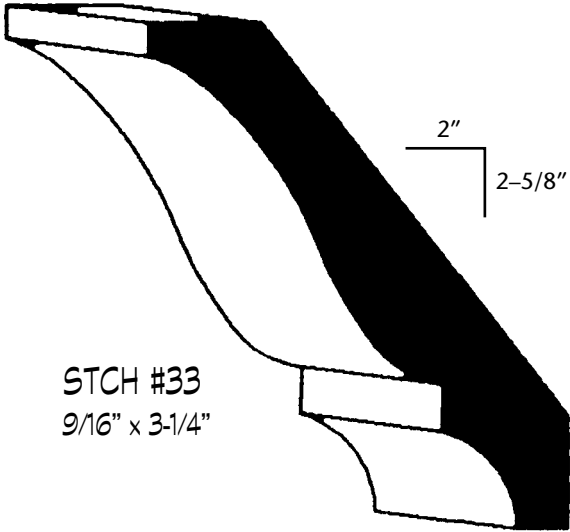

STCH #33
9/16" x 3-1/4"

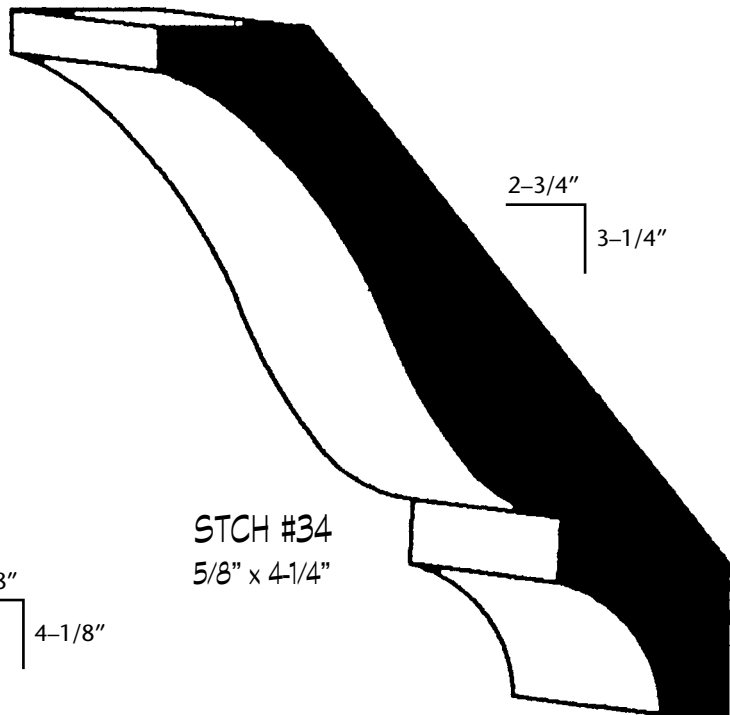

STCH #34
5/8" x 4-1/4"

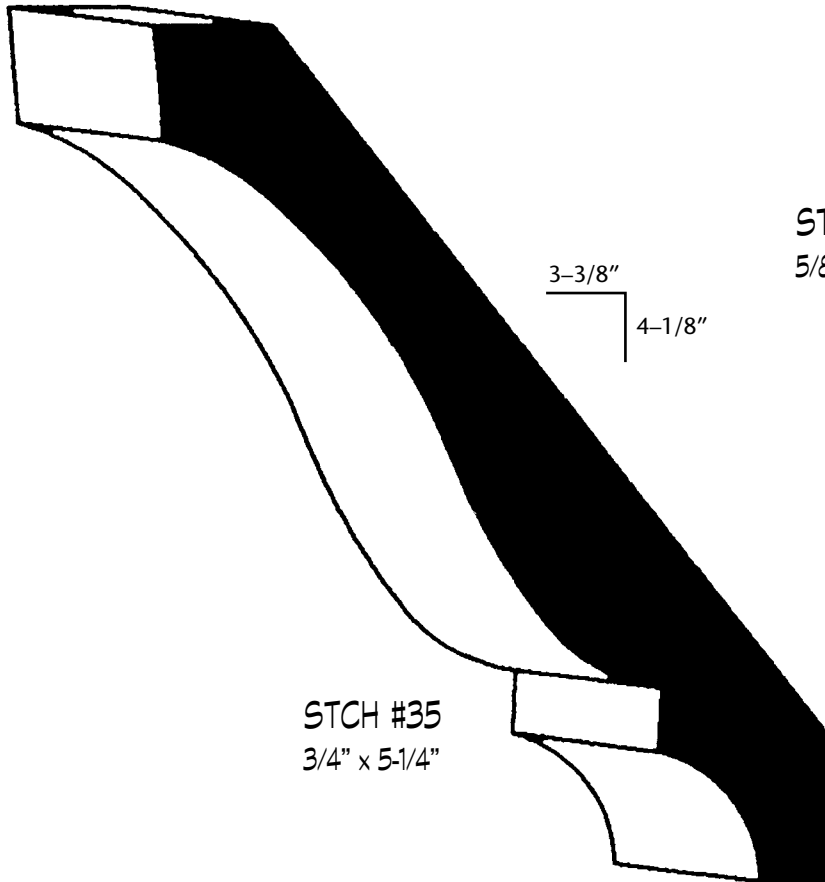

STCH #35
3/4" x 5-1/4"

All items priced per lineal foot • Specific lengths — add 15% • Specified 16' — add 25%

CROWN MOULDINGS

STOCKED PROFILES

*Our mouldings are stocked in Poplar & Red Oak.
Some items are stocked in Birch, Cherry, Walnut, Hard Maple & Pine.*

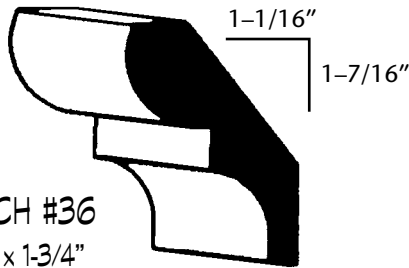

STCH #36
1/2" x 1-3/4"

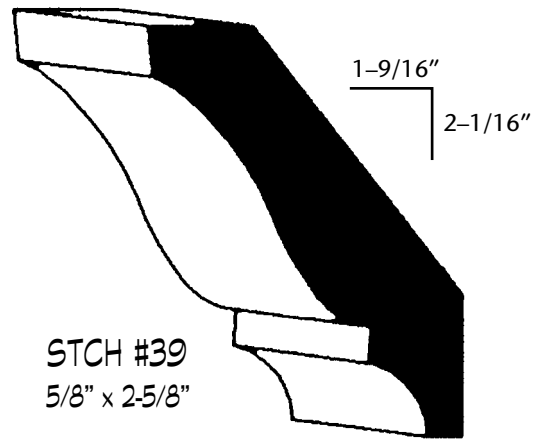

STCH #39
5/8" x 2-5/8"

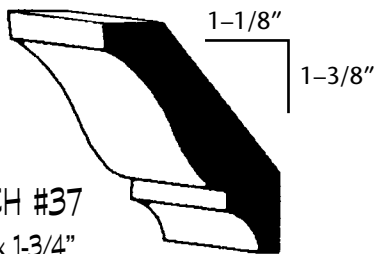

STCH #37
1/2" x 1-3/4"

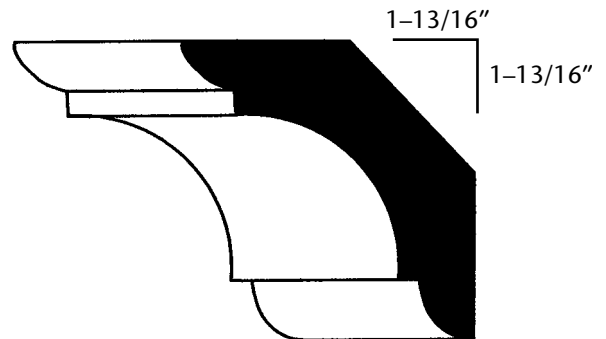

CROWN COVE
STCH #203 • 3/4" x 2-1/2"

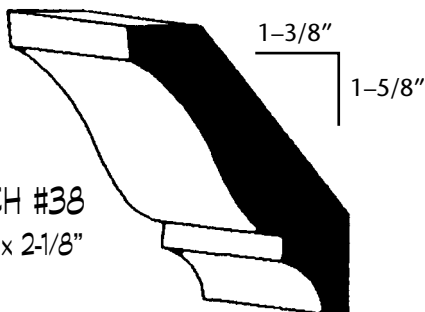

STCH #38
5/8" x 2-1/8"

All items priced per lineal foot • Specific lengths — add 15% • Specified 16' — add 25%

CROWN MOULDINGS

STOCKED PROFILES

*Our mouldings are stocked in Poplar & Red Oak.
Some items are stocked in Birch, Cherry, Walnut, Hard Maple & Pine.*

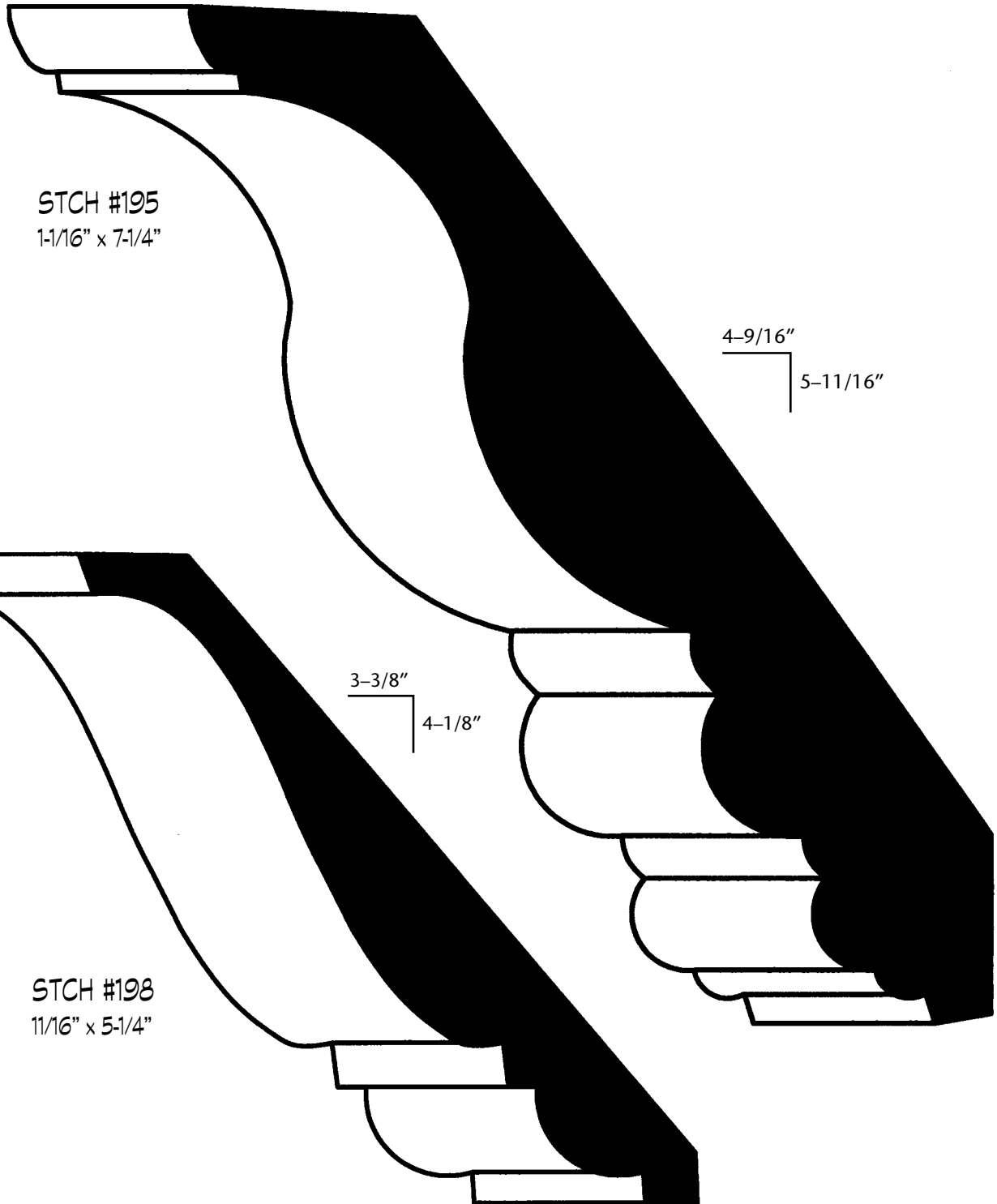

All items priced per lineal foot • Specific lengths — add 15% • Specified 16' — add 25%

CROWN MOULDINGS

STOCKED PROFILES

*Our mouldings are stocked in Poplar & Red Oak.
Some items are stocked in Birch, Cherry, Walnut, Hard Maple & Pine.*

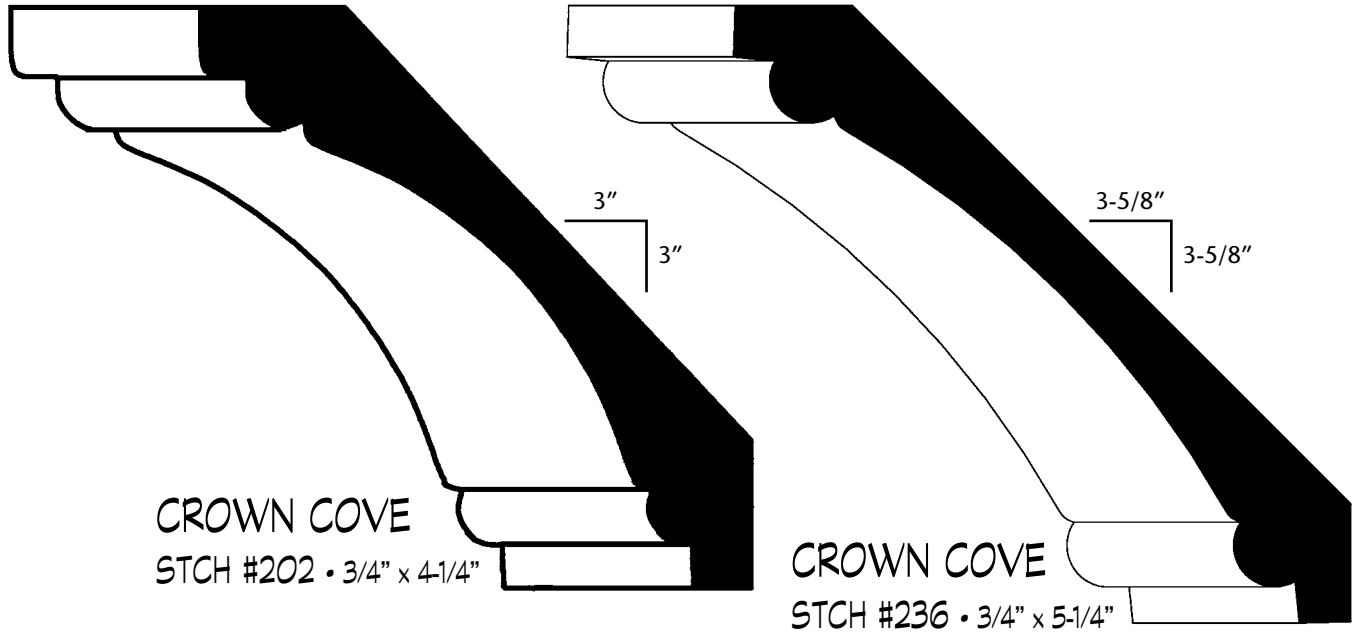

CROWN COVE
STCH #202 • 3/4" x 4 1/4"

CROWN COVE
STCH #236 • 3/4" x 5 1/4"

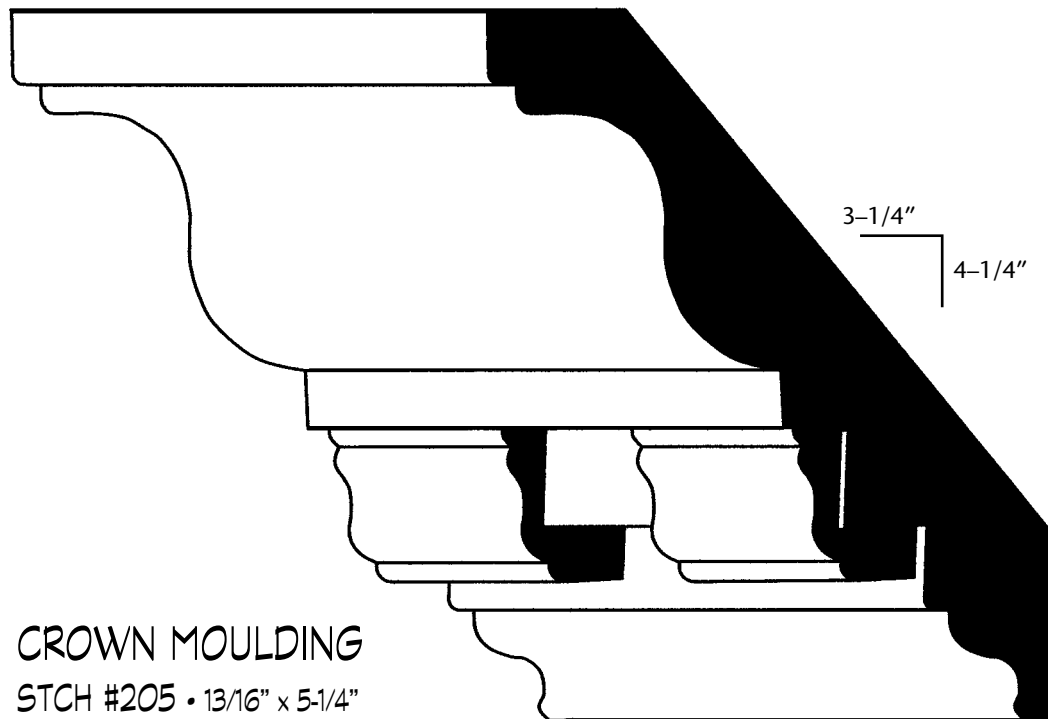

CROWN MOULDING
STCH #205 • 13/16" x 5 1/4"

All items priced per lineal foot • Specific lengths — add 15% • Specified 16'— add 25%

CROWN MOULDINGS

STOCKED PROFILES

Our mouldings are stocked in Poplar & Red Oak.
Some items are stocked in Birch, Cherry, Walnut, Hard Maple & Pine.

DENTIL CROWN

STCH #40 • 13/16" x 5 -1/4"

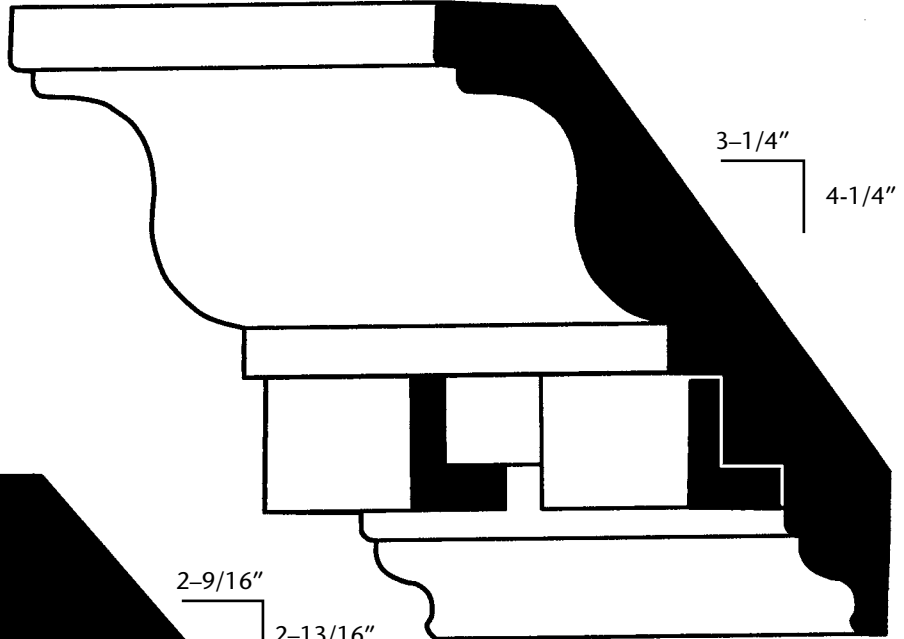

CROWN w/o INSERT

STCH #41 • 13/16" x 3-3/4"

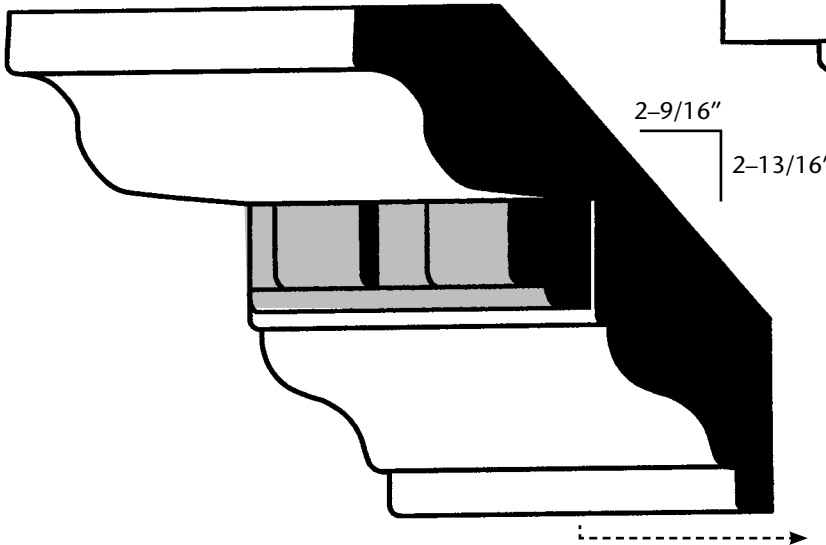

DENTIL INSERT

DENTIL INSERT SOLD AS SEPARATE PIECE

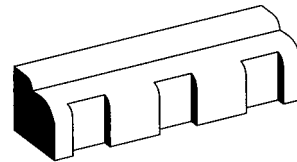

STCH #42 • 1/2" x 5/8"

CROWN w/o INSERT

STCH #221 • 1/2" x 1-3/4"

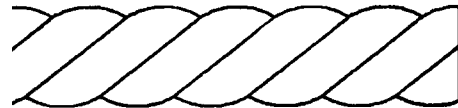
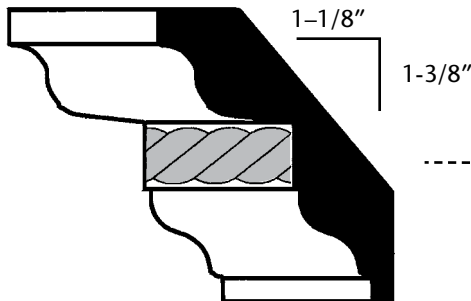

STCH #163 • 11/32" x 3/4" x 96 "

DENTIL INSERT

DENTIL INSERT SOLD AS SEPARATE PIECE

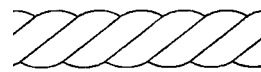

STCH #217 • 1/8" x 3/8" x 96 "

All items priced per lineal foot • Specific lengths — add 15% • Specified 16' — add 25%

CROWN BLOCKS

STOCKED PROFILES

*Our mouldings are stocked in Poplar & Red Oak.
Some items are stocked in Birch, Cherry, Walnut, Hard Maple & Pine.*

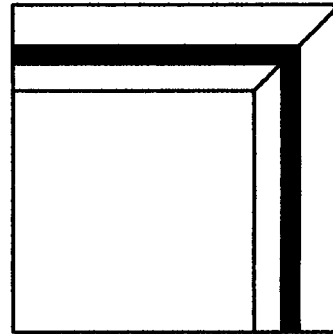
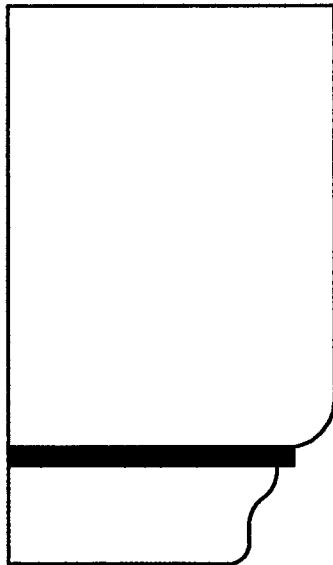

INSIDE

CROWN BLOCKS

STCH #160

2-1/2" x 2-1/2" x 4-1/4"

STCH #161

3" x 3" x 4-3/4"

STCH #162

3-1/2" x 3-1/2" x 6"

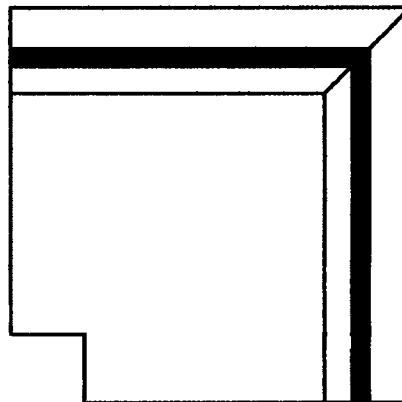
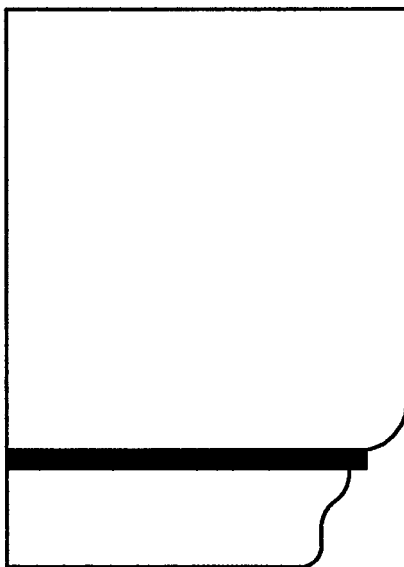

OUTSIDE

CROWN BLOCKS

STCH #160-0

3-3/4" x 3-3/4" x 4-1/4"

STCH #161-0

4-1/4" x 4-1/4" x 4"

STCH #162-0

4-3/4" x 4-3/4" x 6"

All items priced per lineal foot • Specific lengths — add 15% • Specified 16' — add 25%

DENTIL MOULD

STOCKED PROFILES

*Our mouldings are stocked in Poplar & Red Oak.
Some items are stocked in Birch, Cherry, Walnut, Hard Maple & Pine.*

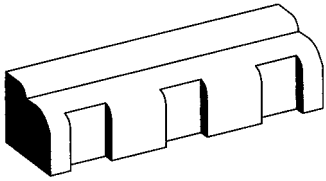

STCH #42 • 1/2" x 5/8"

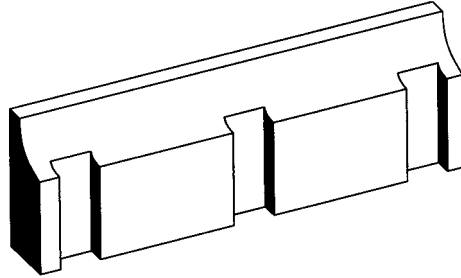

STCH #227 • 3/8" x 1-1/4"

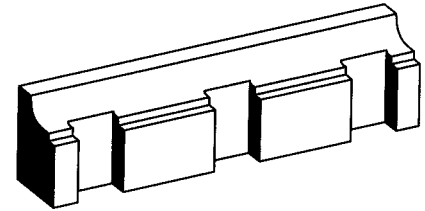

STCH #228 • 3/8" x 3/4"

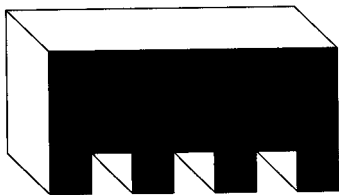

STCH #44 • 1/2" x 1-3/4"

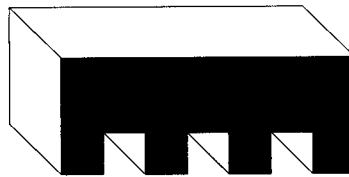

STCH #43 • 5/8" x 1-3/4"

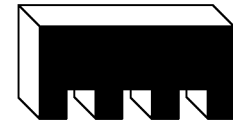

STCH #197 • 5/16" x 1"

ROPE MOULD

STOCKED PROFILES

*Our mouldings are stocked in Poplar & Red Oak.
Some items are stocked in Birch, Cherry, Walnut, Hard Maple & Pine.*

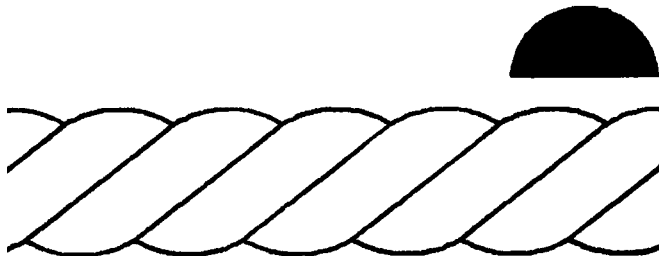

STCH #163 • 11/32" x 3/4" x 96"



STCH #217 • 1/8" x 3/8" x 96"

All items priced per lineal foot • Specific lengths — add 15% • Specified 16' — add 25%

FLOORING ACCESSORIES

STOCKED PROFILES

RED OAK • WHITE OAK • HARD MAPLE

STAIR NOSE

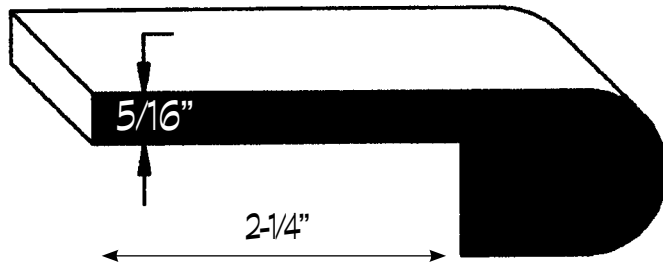

STCH #45 • 1" x 3-1/2"

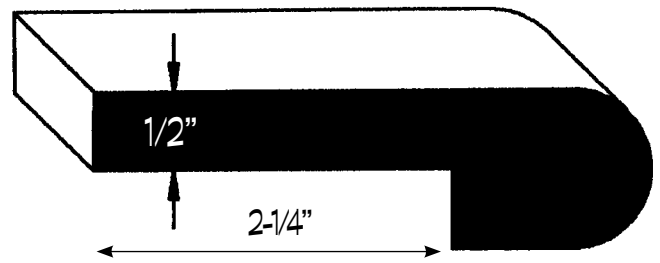

STCH #46 • 1" x 3-1/2"

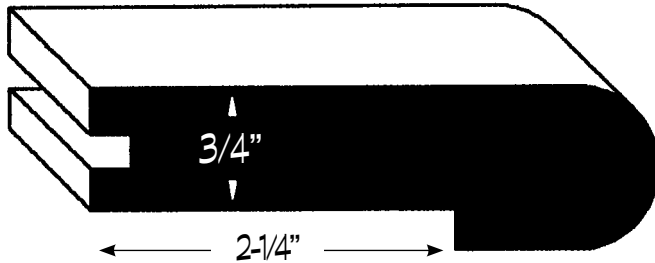

STCH #47 • 1" x 3-1/2"



STCH #171 • 3/4" x 2-3/4"

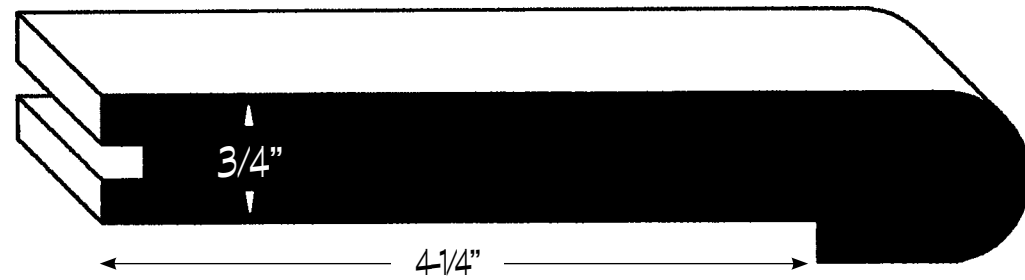

STCH #48 • 1" x 5-1/2"

LIP THRESHOLD

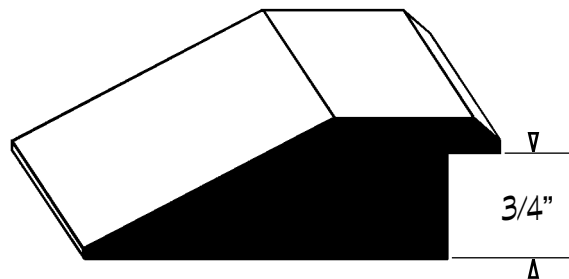

STCH #234 • 1" x 3"

SHIM



STCH #235 • 3/8" x 4-1/2"

All items priced per lineal foot • Specific lengths — add 15% • Specified 16' — add 25%

FLOORING ACCESSORIES

STOCKED PROFILES

RED OAK • WHITE OAK • HARD MAPLE

STRIP



STCH #49 • 5/16" x 2"



STCH #50 • 5/16" x 1-1/2"



STCH #51 • 5/16" x 1"

QUARTER ROUND

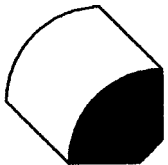

STCH #58 • 3/4" x 3/4"

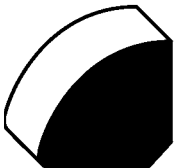

STCH #194 • 1" x 1"

THRESHOLD



STCH #54 • 5/16" x 2"



STCH #55 • 7/16" x 3"

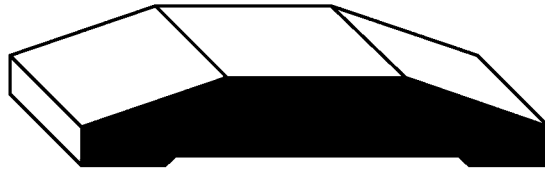

STCH #56 • 5/8" x 3-5/8"



STCH #60 • 3/8" x 1-1/2"

REDUCER



STCH #52 • 3/4" x 2-1/4"



STCH #53 • 1/2" x 2"

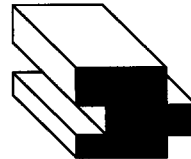

STCH #213 • 3/4" x 1"



STCH #61 • 5/16" x 1-1/2"

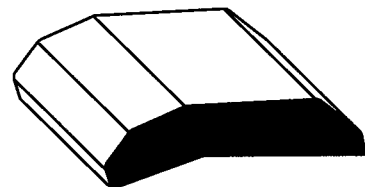

STCH #212 • 17/32" x 2"

All items priced per lineal foot • Specific lengths — add 15% • Specified 16' — add 25%

FLOORING ACCESSORIES

STOCKED PROFILES

RED OAK • WHITE OAK • HARD MAPLE

LIP THRESHOLD

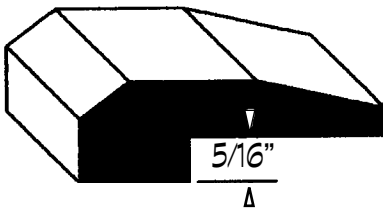

STCH #62 • 3/4" x 2-1/8"

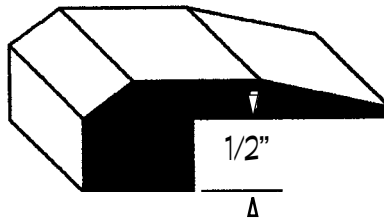

STCH #63 • 3/4" x 2-1/8"

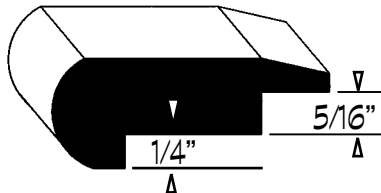

STCH #226 • 13/16" x 2"

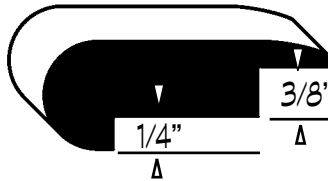

STCH #188 • 13/16" x 2"



STCH #184 • 7/16" x 1-3/32"



STCH #185 • 19/32" x 1-1/2"

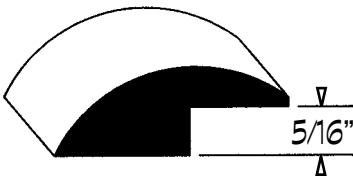

STCH #223 • 17/32" x 1-1/2"

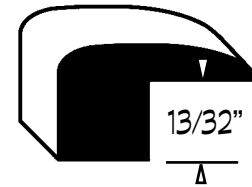

STCH #186 • 19/32" x 1-3/32"

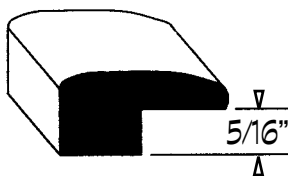

STCH #224 • 1/2" x 1-3/32"

BASE SHOE



STCH #59 • 1/2" x 3/4"

T-MOULD

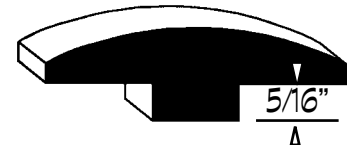

STCH #174 • 5/8" x 2"

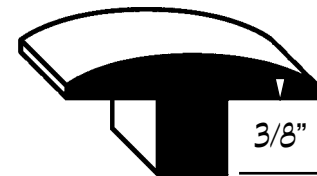

STCH #187 • 5/8" x 1-3/8"

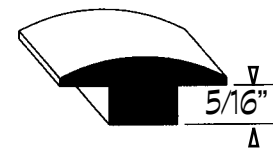

STCH #225 • 9/16" x 1-3/8"

SPLINE



STCH #57 • 1/4" x 1/2"



STCH #57RO-L • 1/8" x 5/16"

All items priced per lineal foot • Specific lengths — add 15% • Specified 16' — add 25%

CHAIR RAIL

STOCKED PROFILES

*Our mouldings are stocked in Poplar & Red Oak.
Some items are stocked in Birch, Cherry, Walnut, Hard Maple & Pine.*

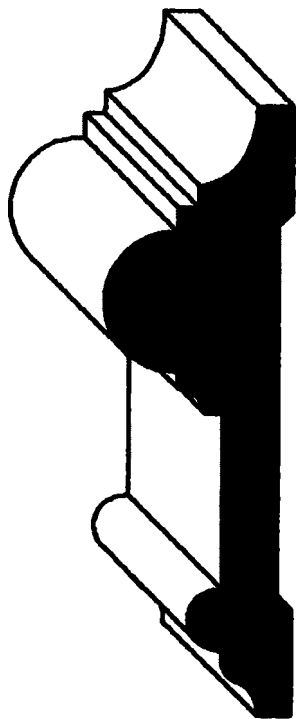

STCH #64 • 13/16" x 3-1/4"

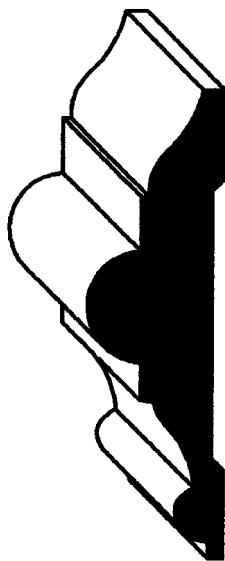

STCH #65 • 7/8" x 3"



STCH #66 • 11/16" x 2-1/2"



STCH #67 • 1/2" x 1-1/32"



STCH #68 • 11/16" x 1-1/2"

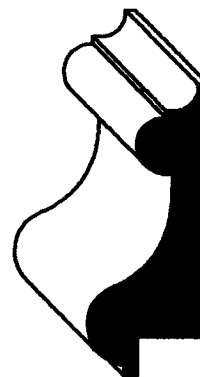

STCH #69 • 13/16" x 2"

All items priced per lineal foot • Specific lengths — add 15% • Specified 16' — add 25%

CHAIR RAIL

STOCKED PROFILES

*Our mouldings are stocked in Poplar & Red Oak.
Some items are stocked in Birch, Cherry, Walnut, Hard Maple & Pine.*



STCH #70 • 3/4" x 2-1/4"



STCH #71 • 9/16" x 2-1/2"



STCH #128 • 7/16" x 2"



CHAIR RAIL CAP
STCH #207 • 3/4" x 1-9/16"

All items priced per lineal foot • Specific lengths — add 15% • Specified 16' — add 25%

PANEL MOULDING

STOCKED PROFILES

*Our mouldings are stocked in Poplar & Red Oak.
Some items are stocked in Birch, Cherry, Walnut, Hard Maple & Pine.*



STCH #72 • 11/16" x 1-3/4"



STCH #79 • 11/16" x 1-3/4"



STCH #201 • 1/4" x 17/32"



STCH #73 • 11/16" x 1-3/8"



STCH #200 • 9/16" x 1-3/16"



STCH #76 • 7/16" x 1-1/4"

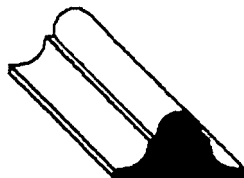

STCH #74 • 11/32" x 5/8"



STCH #75 • 5/16" x 15/16"

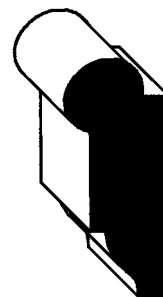

STCH #77 • 3/4" x 1-3/4"

All items priced per lineal foot • Specific lengths — add 15% • Specified 16' — add 25%

PANEL MOULDING

STOCKED PROFILES

*Our mouldings are stocked in Poplar & Red Oak.
Some items are stocked in Birch, Cherry, Walnut, Hard Maple & Pine.*

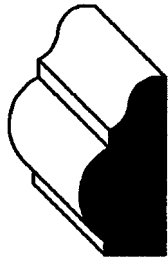

STCH #78 • 9/16" x 1-1/4"



STCH #80 • 11/16" x 1-3/8"

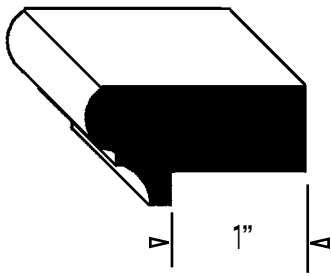

STCH #81 • 7/8" x 1-5/8"

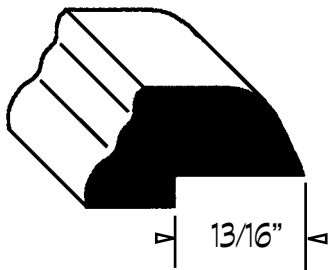

STCH #82 • 11/16" x 1-5/16"

RAISED PANEL

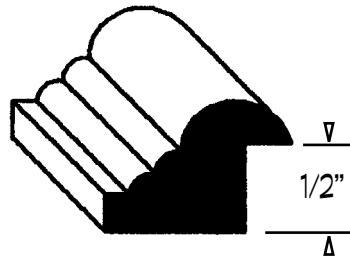

STCH #83 • 11/16" x 1"

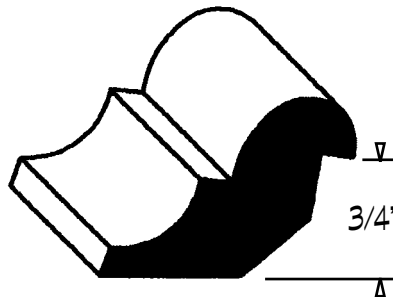

STCH #84 • 9/16" x 1-5/8"

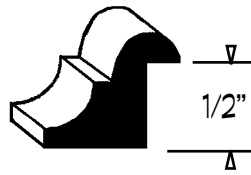

STCH #178 • 5/8" x 3/4"

SCRIBE



STCH #176 • 1/2" x 3/4"

GLASS BEAD



STCH #177 • 3/8" x 3/8"

RAISED PANEL MOULD

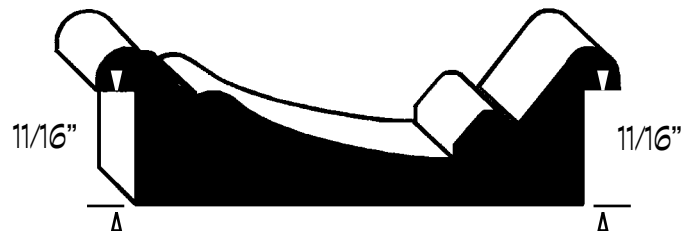
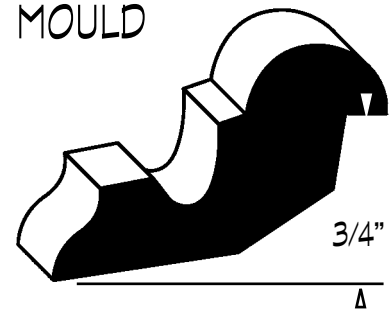

STCH #232 • 7/8" x 3"

All items priced per lineal foot • Specific lengths — add 15% • Specified 16' — add 25%

PICTURE FRAME

STOCKED PROFILES

*Our mouldings are stocked in Poplar & Red Oak.
Some items are stocked in Birch, Cherry, Walnut, Hard Maple & Pine.*

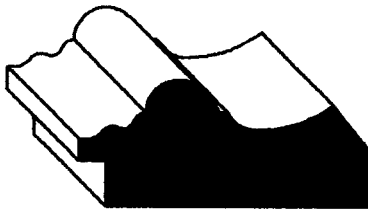

STCH #85 • 13/16" x 2"

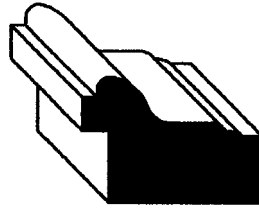

STCH #86 • 7/8" x 1-1/4"

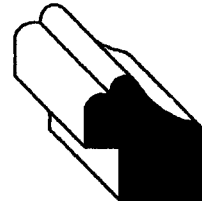

STCH #87 • 3/4" x 7/8"

CABINET PARTS

STOCKED PROFILES

*Our mouldings are stocked in Poplar & Red Oak.
Some items are stocked in Birch, Cherry, Walnut, Hard Maple & Pine.*



STCH #89 • 13/16" x 2"

FRAME MOULD

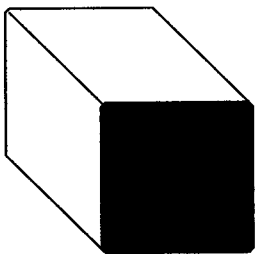

STCH #219 • 1-1/8" x 1-1/8"

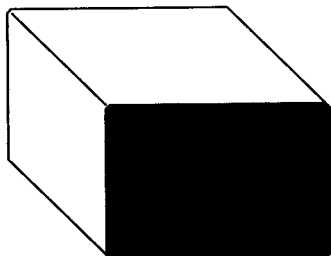

STCH #220 • 1-1/8" x 1-5/8"

BEAD MOULD

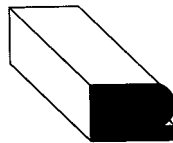

STCH #216 • 1/2" x 3/4"

RADIUS CORNER



STCH #175 • 1-1/16" x 2-7/8"

BEADED RADIUS CORNER



STCH #189 • 3/4" x 2-11/16"



STCH #90
7/16" x 4-7/16"

All items priced per lineal foot • Specific lengths — add 15% • Specified 16' — add 25%

CAP MOULD

STOCKED PROFILES

*Our mouldings are stocked in Poplar & Red Oak.
Some items are stocked in Birch, Cherry, Walnut, Hard Maple & Pine.*

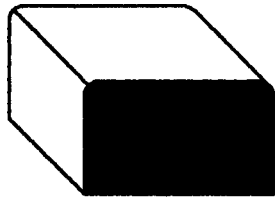

STCH #103 • 3/4" x 1-1/4"

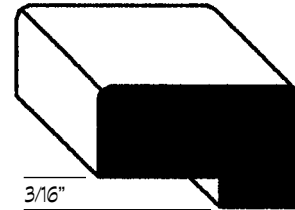

STCH #104 • 3/4" x 1-1/4"

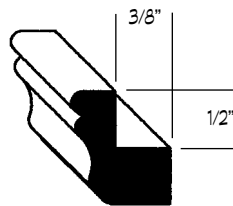

STCH #105 • 13/16" x 15/16"



STCH #106 • 7/16" x 7/8"

SCREEN MOULD

STOCKED PROFILES

*Our mouldings are stocked in Poplar & Red Oak.
Some items are stocked in Birch, Cherry, Walnut, Hard Maple & Pine.*



STCH #107 • 1/4" x 1-1/8"



STCH #108 • 1/4" x 3/4"

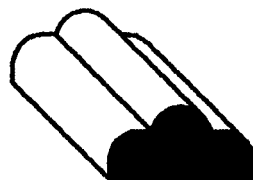

STCH #109 • 3/8" x 3/4"

CLOVER BEAD



STCH #182 • 5/16" x 1/2"

All items priced per lineal foot • Specific lengths — add 15% • Specified 16' — add 25%

OUTSIDE CORNERS

STOCKED PROFILES

*Our mouldings are stocked in Poplar & Red Oak.
Some items are stocked in Birch, Cherry, Walnut, Hard Maple & Pine.*

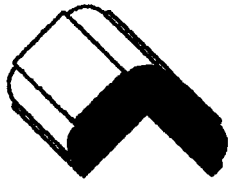

STCH #91 • 3/4" x 3/4"

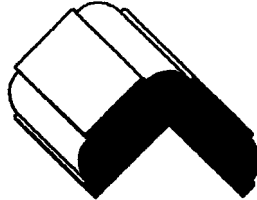

STCH #92 • 1-1/8" x 1-1/8"

22° OUTSIDE CORNER



STCH #183 • 3/8" x 1"

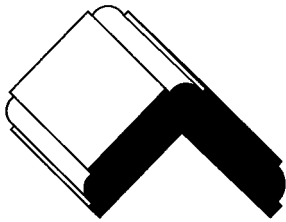

STCH #211 • 1-1/2" x 1-1/2"

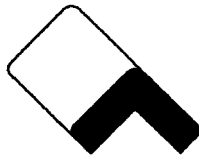

STCH #93 • 3/4" x 3/4"

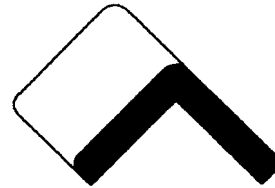

STCH #94 • 1-1/4" x 1-1/4"

QUARTER ROUND

STOCKED PROFILES

*Our mouldings are stocked in Poplar & Red Oak.
Some items are stocked in Birch, Cherry, Walnut, Hard Maple & Pine.*



STCH #97 • 3/8" x 3/8"



STCH #98 • 1/2" x 1/2"

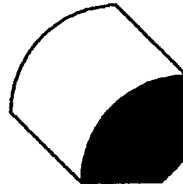

STCH #58 • 3/4" x 3/4"

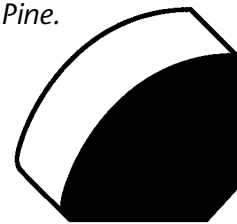

STCH #194 • 1" x 1"

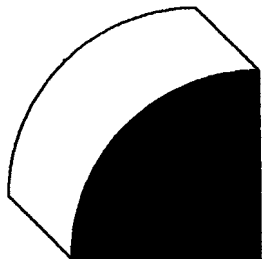

STCH #102
1-1/2" x 1-1/2"

BEADED QUARTER ROUNDS

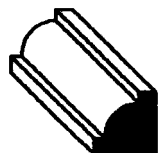

STCH #95
3/8" x 3/8"



STCH #181
1/2" x 1/2"

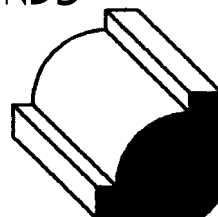

STCH #96
3/4" x 3/4"

BASE SHOE



STCH #59
1/2" x 3/4"

All items priced per lineal foot • Specific lengths — add 15% • Specified 16' — add 25%

COVE MOULDINGS

STOCKED PROFILES

*Our mouldings are stocked in Poplar & Red Oak.
Some items are stocked in Birch, Cherry, Walnut, Hard Maple & Pine.*

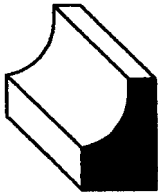

STCH #101 • 1/2" x 3/4"

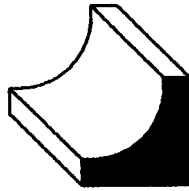

STCH #99 • 3/4" x 3/4"

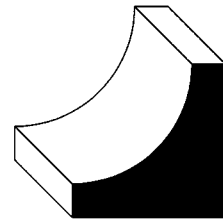

STCH #233 • 1" x 1"

GLASS BEAD



STCH #177 • 3/8" x 3/8"

SCRIBE



STCH #176 • 1/2" x 3/4"

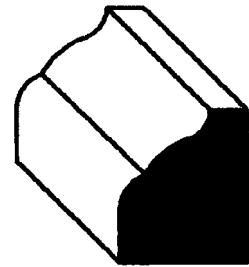

STCH #100 • 5/8" x 3/4"

BRICK MOULD

STOCKED PROFILES

*Our mouldings are stocked in Poplar & Red Oak.
Some items are stocked in Birch, Cherry, Walnut, Hard Maple & Pine.*

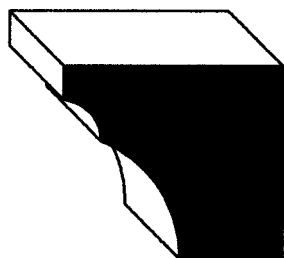

STCH #120 • 1-3/4" x 2"

CAP MOULDS



STCH #206 • 1-1/16" x 2"

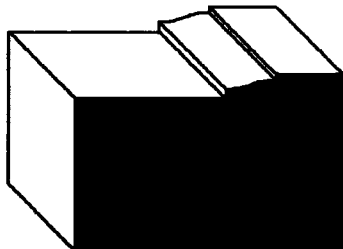

STCH #121 • 1-5/16" x 2"

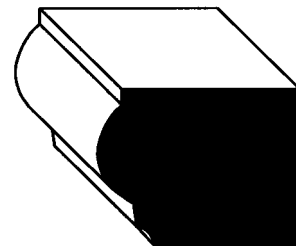

STCH #229 • 1-1/16" x 1-3/8"

All items priced per lineal foot • Specific lengths — add 15% • Specified 16' — add 25%

HALF ROUNDS

STOCKED PROFILES

*Our mouldings are stocked in Poplar & Red Oak.
Some items are stocked in Birch, Cherry, Walnut, Hard Maple & Pine.*

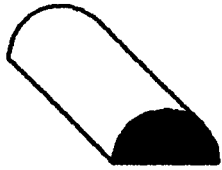

STCH #110 • 1/4" x 1/2"

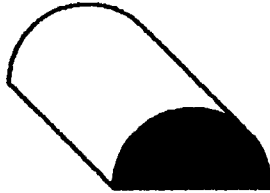

STCH #111 • 3/8" x 3/4"

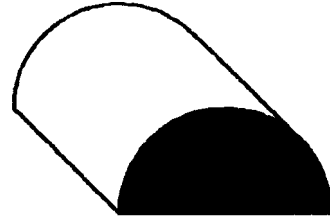

STCH #112 • 1/2" x 1"

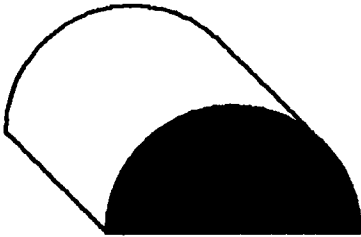

STCH #113 • 5/8" x 1-1/4"

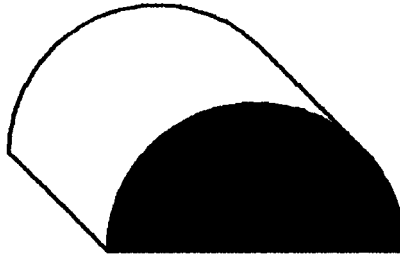

STCH #114 • 3/4" x 1-1/2"

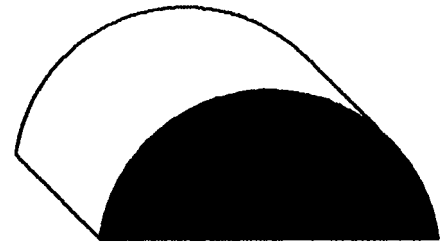

STCH #115 • 7/8" x 2"

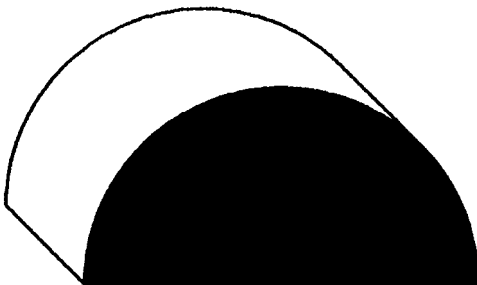

STCH #116 • 1-1/8" x 2-1/4"

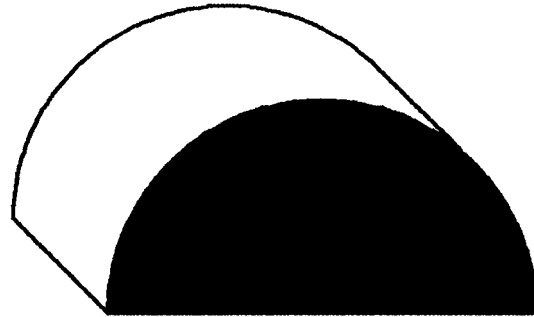

STCH #117 • 1-1/4" x 2-1/2"

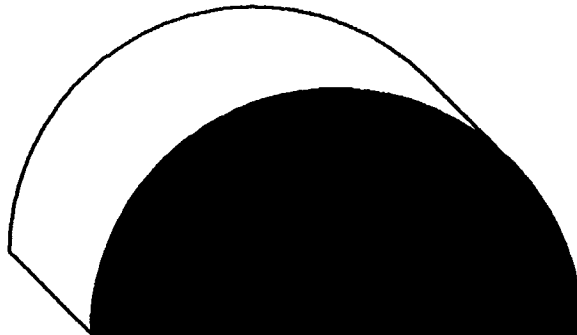

STCH #118 • 1-1/2" x 3"

All items priced per lineal foot • Specific lengths — add 15% • Specified 16' — add 25%

MANTEL MOULD

STOCKED PROFILES

*Our mouldings are stocked in Poplar & Red Oak.
Some items are stocked in Birch, Cherry, Walnut, Hard Maple & Pine.*

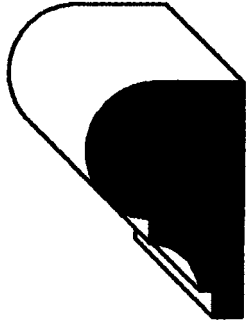

STCH #122 • 1-1/16" x 1-1/2"

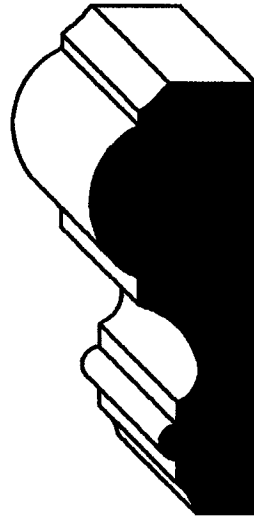

STCH #124 • 1-1/16" x 2-3/4"



STCH #125 • 1-1/4" x 5-3/8"



STCH #123 • 1" x 2"



STCH #172 • 1-3/4" x 6"

All items priced per lineal foot • Specific lengths — add 15% • Specified 16' — add 25%

TONGUE & GROOVE PANELING

STOCKED PANELS

*Our panels sections are stocked in Poplar & Red Oak.
Some panel sections are stocked in Birch, Cherry, Walnut, Hard Maple & Pine.*

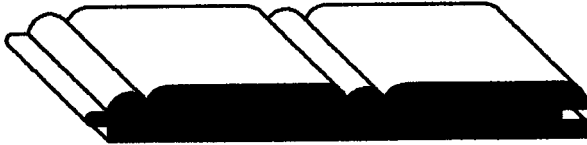

BEADED PANELING
STCH #129 • 11/32" x 3-1/8"



CHAIR RAIL
STCH #70 • 3/4" x 2-1/4"

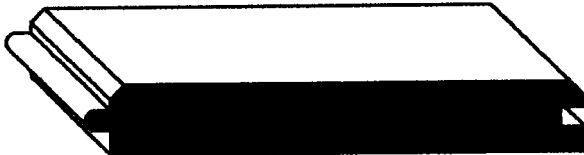

CLOSET LINER*
STCH #130 • 5/16" x 3-3/8"



CHAIR RAIL CAP
STCH #207 • 3/4" x 1-9/16"



T&G PANELING
STCH #204 • 11/32" x 3-1/8"

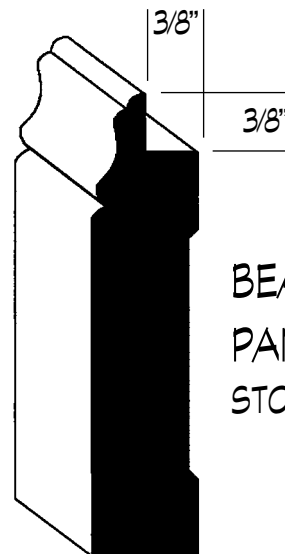

**BEADED
PANEL BASE**
STCH #168 • 11/16" x 3"



*AVAILABLE IN CEDAR ONLY • 96" LENGTHS / 21.67 SQ. FT. PER BOX

All items priced per lineal foot • Specific lengths — add 15% • Specified 16' — add 25%

JAMBS & SILLS

STOCKED PROFILES

*Our mouldings are stocked in Poplar & Red Oak.
Some items are stocked in Birch, Cherry, Walnut, Hard Maple & Pine.*

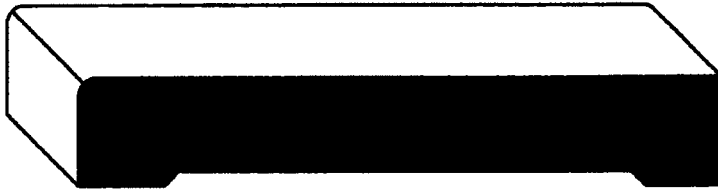

JAMB
STCH #131 • 3/4" x 4-9/16"



SILL
STCH #135 • 7/8" x 2-1/4"

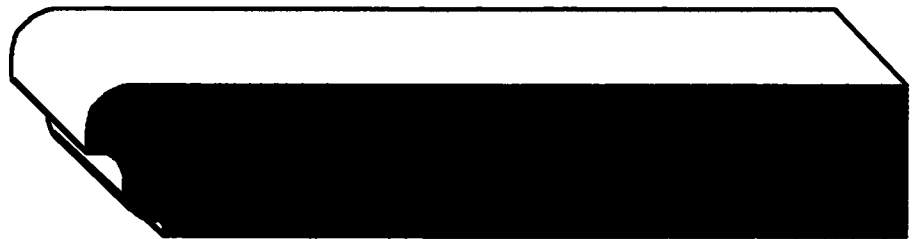

SILL
STCH #134 • 1" x 5-1/2"

STAIR PARTS

STOCKED PROFILES

*Our mouldings are stocked in Poplar & Red Oak.
Some items are stocked in Birch, Cherry, Walnut, Hard Maple & Pine.*

HAND RAIL

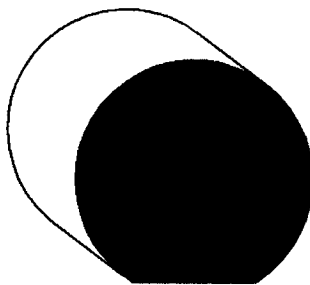

STCH #169 • 1-5/8" x 1-3/4"

BALUSTER STOCK

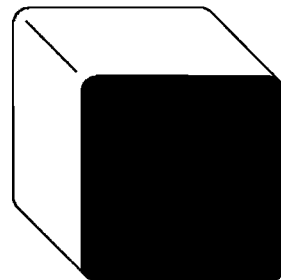

STCH #173 • 1-1/2" x 1-1/2"

FILLET



STCH #214
5/16" x 1-3/4"



STCH #215
5/16" x 1-1/4"

All items priced per lineal foot • Specific lengths — add 15% • Specified 16' — add 25%

PLINTH BLOCKS

STOCKED PROFILES

*Our mouldings are stocked in Poplar & Red Oak.
Some items are stocked in Birch, Cherry, Walnut, Hard Maple & Pine.*

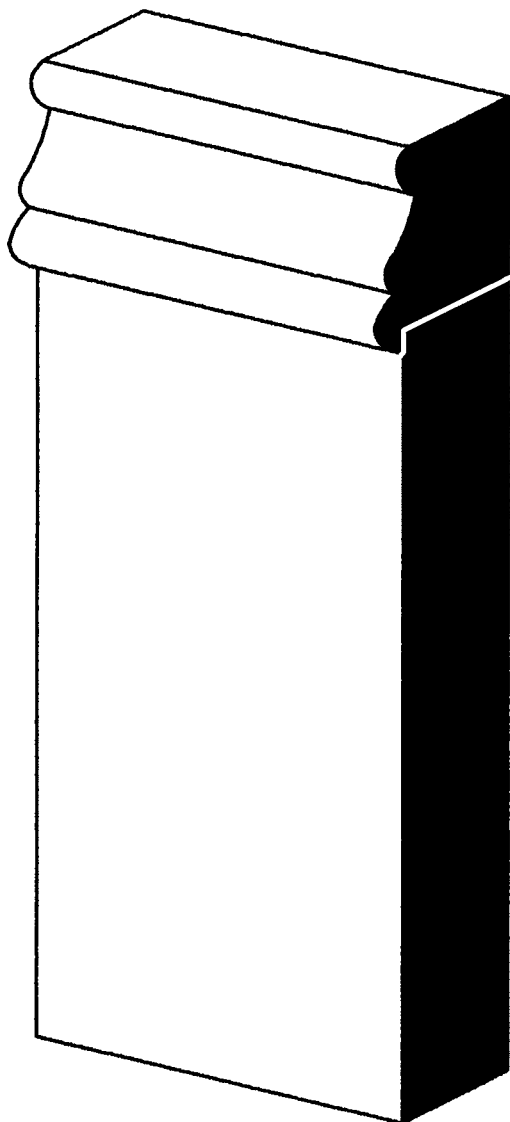

- STCH #136 • 2-1/2" x 6-1/2"
- STCH #137 • 3-1/2" x 6-1/2"
- STCH #138 • 4-1/2" x 9"
- STCH #139 • 5-1/2" x 9"

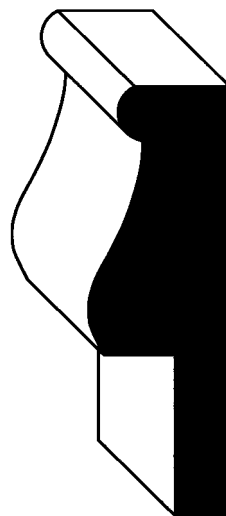

STCH #230
1-1/4" x 4"

TOP ON
4-1/2" & 5-1/2"

STCH #140
1-5/16" x 2-1/4"

TOP ON
2-1/2" & 3-1/2"

STCH #141
15/16" x 1-3/8"

All items priced per lineal foot • Specific lengths — add 15% • Specified 16' — add 25%

ROSETTES

STOCKED PROFILES

*Our mouldings are stocked in Poplar & Red Oak.
Some items are stocked in Birch, Cherry, Walnut, Hard Maple & Pine.*

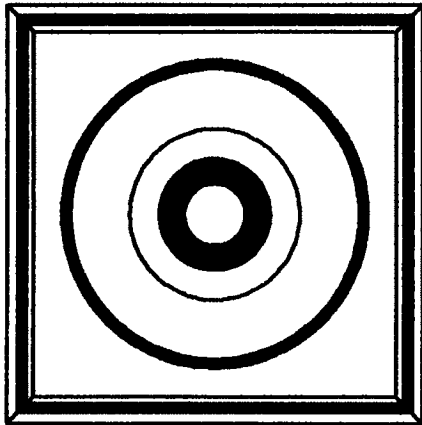

- STCH #142 • 1-1/16" x 2-1/2" x 2-1/2"
 STCH #143 • 1-1/16" x 3-1/2" x 3-1/2"
 STCH #144 • 1-1/16" x 4-1/2" x 4-1/2"
 STCH #145 • 1-1/16" x 5-1/2" x 5-1/2"

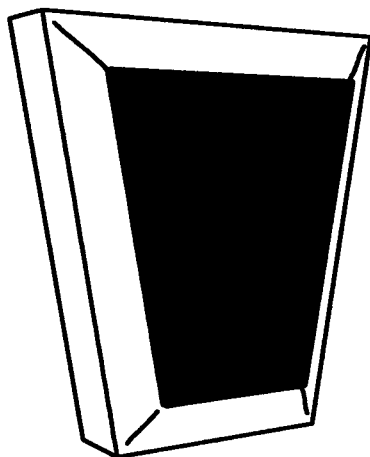

- STCH #208 • 1" x 4" x 4-3/4"
 STCH #209 • 1" x 4-1/2" x 5-1/2"
 STCH #210 • 1" x 5" x 7"



CIRCLE
 STCH #149
 3/4" x 4-3/4"



OVAL
 STCH #148
 3/4" x 4-1/2" x 6-1/2"

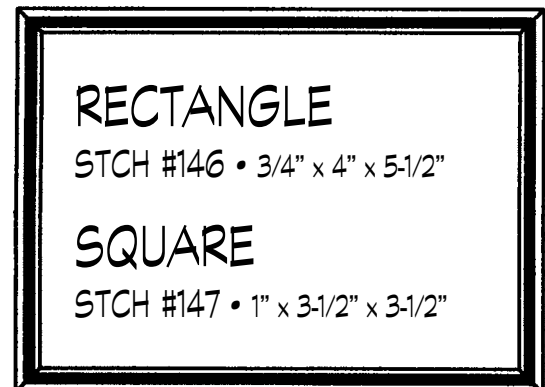

RECTANGLE

STCH #146 • 3/4" x 4" x 5-1/2"

SQUARE

STCH #147 • 1" x 3-1/2" x 3-1/2"

All items priced per lineal foot • Specific lengths — add 15% • Specified 16' — add 25%

SHELF BRACKETS

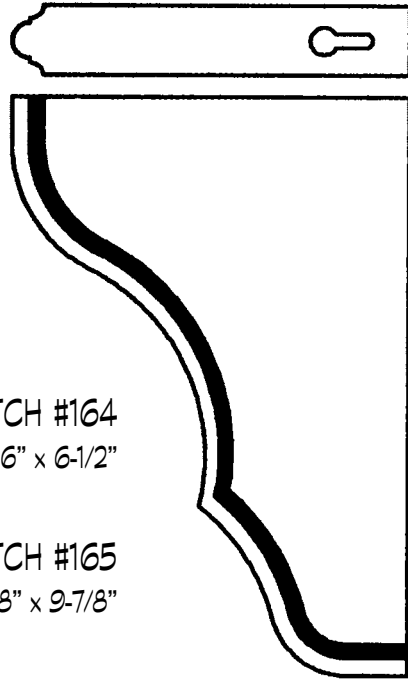

STCH #164
3/4" x 4-7/16" x 6-1/2"

STCH #165
1-1/4" x 7-7/8" x 9-7/8"

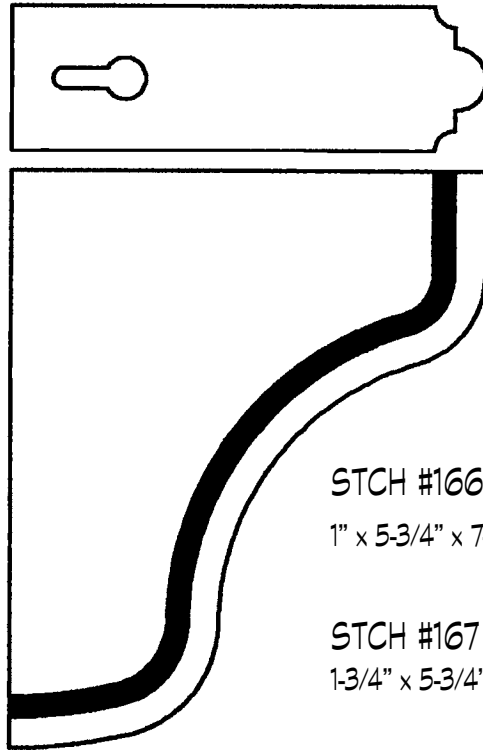

STCH #166
1" x 5-3/4" x 7-1/4"

STCH #167
1-3/4" x 5-3/4" x 7-1/8"



MANTELS

St. Charles Hardwoods stocks fireplace mantels in several species of wood as well as several sizes. Many other sizes, shapes and species are available upon request. We are a custom mill shop so we can produce your next mantel. Please call for more information and prices.

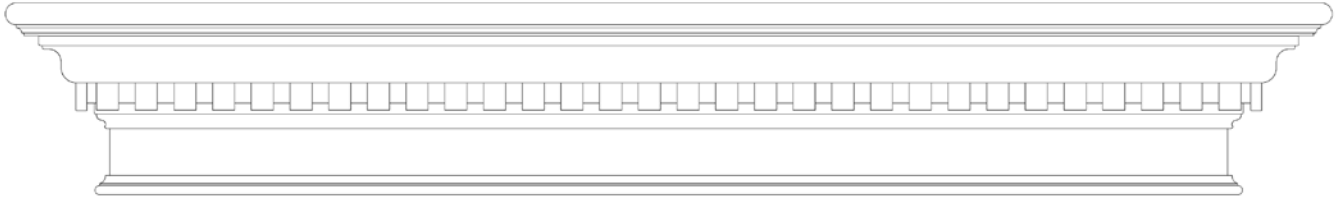

WHITMOOR MANTEL

Red Oak or Birch • 60" or 72"



BOX MANTEL

Smooth or Rough Sawn • Red Oak or Birch • 60" or 72"



CLASSIC MANTEL

Red Oak or Birch • 60" or 72"



HANDHEWN MANTELS

Now in Stock

WOOD FLOORING

UNFINISHED HARDWOOD FLOORING

We stock unfinished flooring in 2-1/4" and 3-1/4" widths.
 Species include Red Oak, White Oak and Fir.
 Hickory, Cherry, Hard Maple and Ash are available for order.



RED OAK

3/4" X 2-1/4"
 3/4" X 3-1/4"

WHITE OAK

3/4" X 2-1/4"

FIR

3/4" X 3-1/4"

WOOD FLOOR REGISTERS

CUSTOM AIR RETURNS ALSO AVAILABLE

Our registers are stocked in Red Oak, Hard Maple, White Oak, Hickory,
 Cherry, Walnut, Tigerwood, Cumaru and Brazilian Cherry.

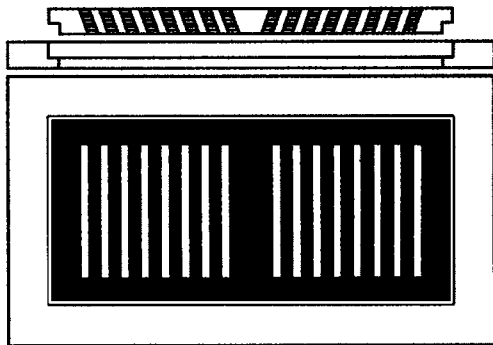

FLUSH MOUNTED

3/4" x 4" x 10" • 3/4" x 4" x 12"

OAK & MAPLE ONLY

3/4" x 2" x 10" • 3/4" x 2" x 12"

NOW STOCKING

1/2" x 4" x 10" - RED OAK & HICKORY ONLY

DAMPER SOLD SEPARATELY

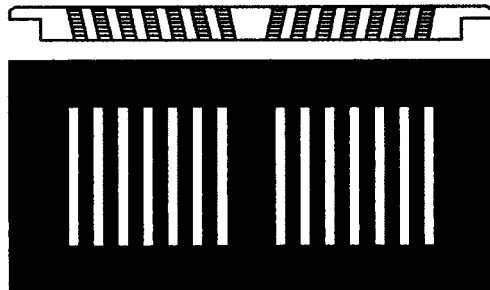

DROP-IN

4" x 10" • 4" x 12"

OAK & MAPLE ONLY

2" x 10" • 2" x 12"

DAMPER SOLD SEPARATELY

INSTALLATION TIPS FOR HARDWOOD FLOORS

UNFINISHED & PREFINISHED FLOORING

Many flooring selections are available. Please call for more information.

Acclimation: Temperature and humidity levels are critical to wood tolerances. Storing wood for four or five days where it will be worked or installed will help eliminate many “winter time cracks.” Hardwood flooring for example, left to acclimatize in a high humidity, or non-air conditioned areas, will expand before installation. This will cause the edges of adjoining pieces to result in cracks when it dries. Water is always present in wood. Wood responds to the amount of humidity in the air. In other words, water enters and leaves wood and changes its volume and properties.

Check for the following conditions and if they exist, correct them:

- Water under the house or excessive moisture under the house
- Insufficient ventilation under the house
- Wet subfloors
- Inadequate moisture retarder

To maintain moisture levels do not load or unload trucks in rain, snow or other excessively humid conditions.

CRAWL SPACE CONSTRUCTION - A ground cover of 4 - 6 mil polyethylene is essential as moisture retarder. Ventilation must be provided with no dead air areas.

CONCRETE SLAB CONSTRUCTION - Proper on grade construction requires both a vapor retarder between the gravel fill and the slab to prevent moisture entry through the slab, and a vapor retarder on top of the slab to prevent moisture from reaching the finished floor.

SUBFLOORS - With 3/4" thick strip flooring use either kiln-dried boards of No. 1 or No. 2 Common Pine or other dense Group #1 Softwood suitable for subfloors over wood.

HANDLING & STORAGE - Flooring should be stored in a dry, well ventilated warehouse. Recently manufactured flooring should be allowed to acclimate to the area.

BEFORE DELIVERY OF FLOORING - the building must be closed-in with outside windows and doors in place and sheetrock installed. all concrete, masonry and framing members, etc. should be thoroughly dry. Never pour concrete after flooring is delivered.

AFTER DELIVERY OF FLOORING - flooring should be broken-up into small lots and stored in the rooms where it will be installed. Allow 4-5 days for flooring to become acclimated to that particular job site. Temperature and humidity should be maintained at or near occupancy levels.



FJ PRIMED POPLAR

STOCKED PROFILES

CROWN

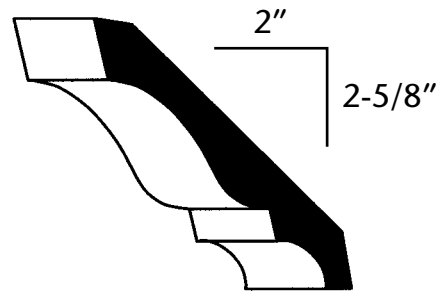
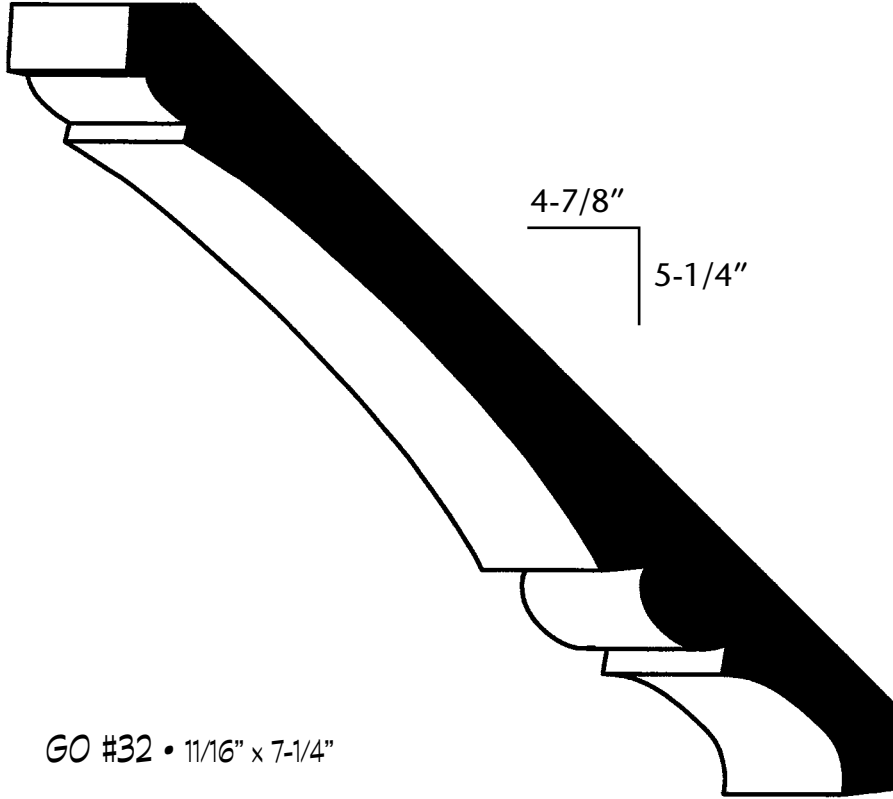

All items priced per lineal foot • Specific lengths — add 15% • Specified 16' — add 25%

FJ PRIMED POPLAR

STOCKED PROFILES

CASING

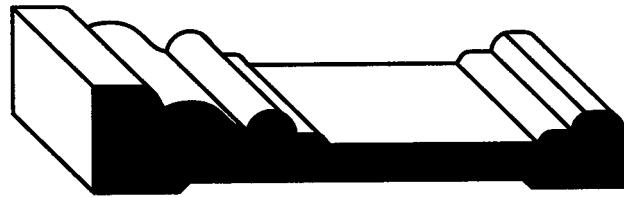

GO #722 • 3/4" x 3-1/2"

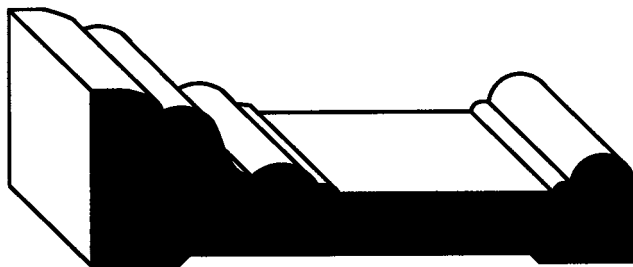

RB3 • 1-1/16" x 3-1/2"
"Primed Pine"

All items priced per lineal foot • Specific lengths — add 15% • Specified 16' — add 25%



FJ PRIMED POPLAR

STOCKED PROFILES

BASE

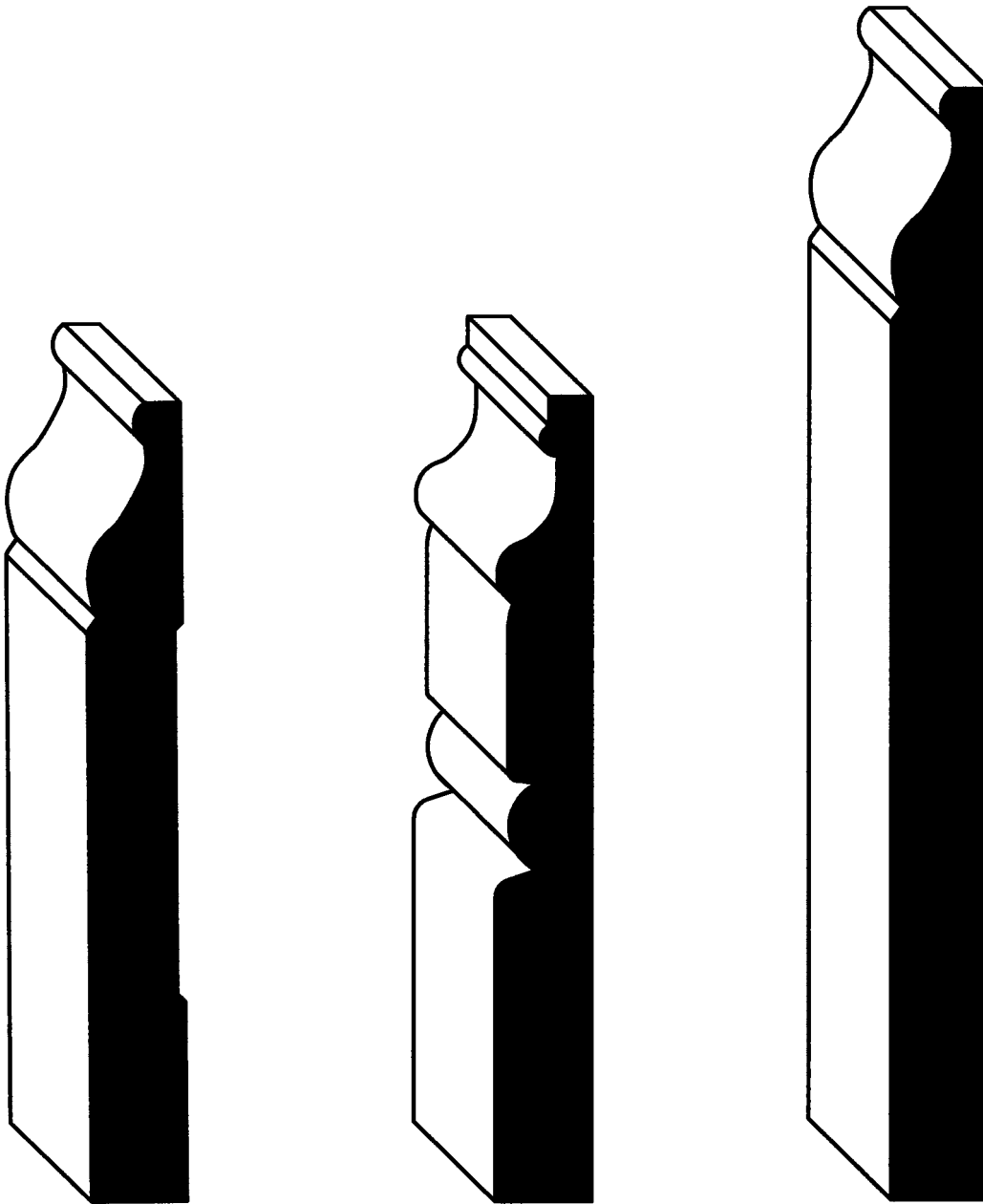

WP9728 • 5/8" x 5-1/4"
"Primed Pine"

GO #763 • 5/8" x 5-1/4"

GO #777 • 5/8" x 7-1/4"

All items priced per lineal foot • Specific lengths — add 15% • Specified 16' — add 25%

FJ PRIMED PINE

STOCKED PROFILES

BASE SHOE



WM126PR • 1/2" x 3/4"

BASE

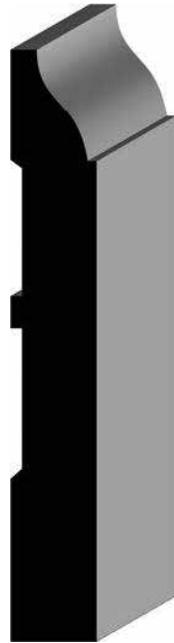

LWM633 • 7/16" x 3-1/4"



WM623 • 9/16" x 3-1/4"

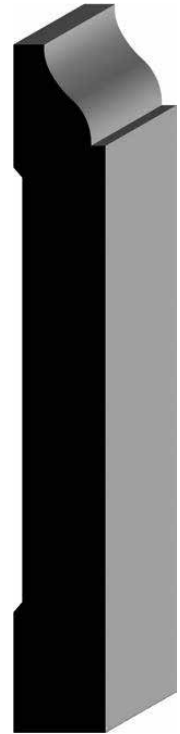

WM620 • 9/16" x 4-1/4"

CASING

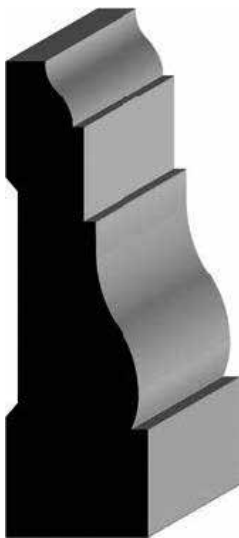

WM366 • 11/16" x 2-1/4"



LWM356 • 11/16" x 2-1/4"

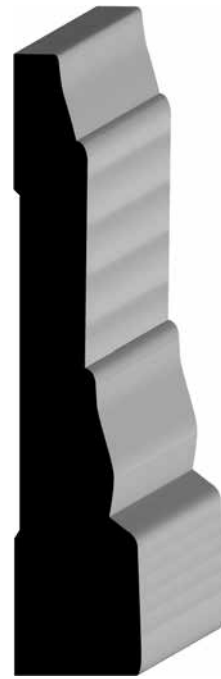

LWM332 • 11/16" x 3-1/4"

All items priced per lineal foot • Specific lengths — add 15% • Specified 16' — add 25%

FJ PRIMED PINE

STOCKED PROFILES

QUARTER ROUND



WM105PR • 3/4" x 3/4"

CHAIR RAIL



LWM390 • 1 1/16" x 2-5/8"

CROWN

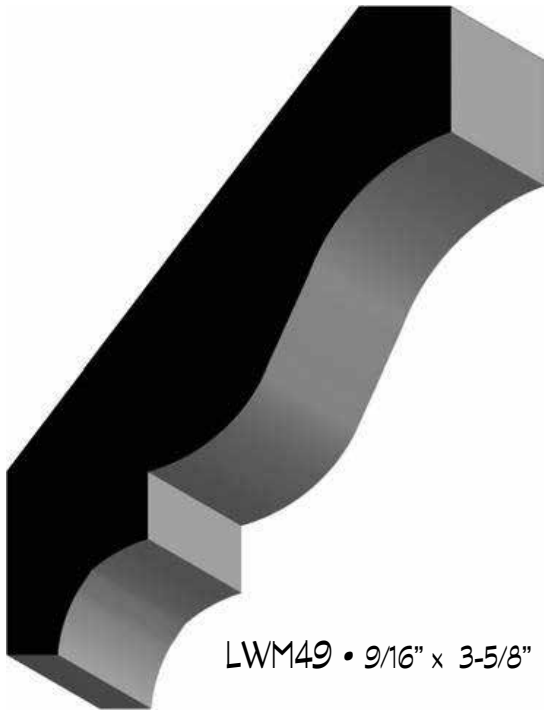

LWM49 • 9/16" x 3-5/8"

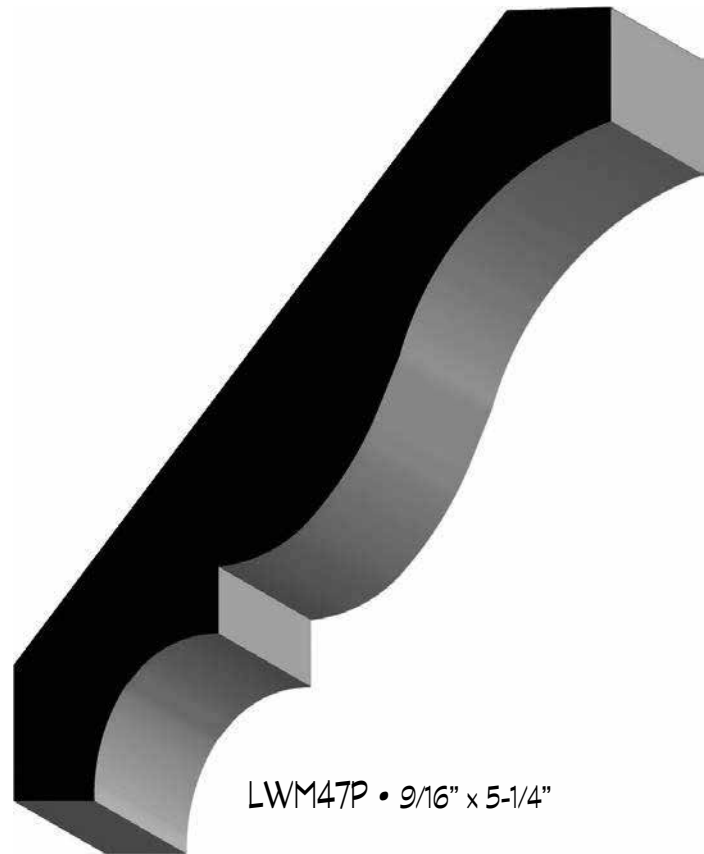

LWM47P • 9/16" x 5-1/4"

All items priced per lineal foot • Specific lengths — add 15% • Specified 16' — add 25%

SOLID PINE

STOCKED PROFILES

BASE SHOE



WM126 • 1/2" x 3/4"

BASE



LWM633PN • 7/16" x 3-1/4"



WM623PN • 9/16" x 3-1/4"



WM620PN • 9/16" x 4-1/4"

CASING

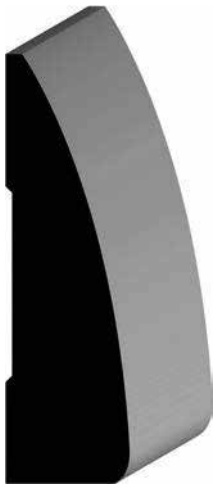

WM327 • 11/16" x 2-1/4"



WM356 • 11/16" x 2-1/4"

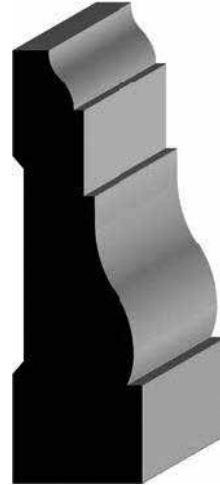

WM366PN • 11/16" x 2-1/4"

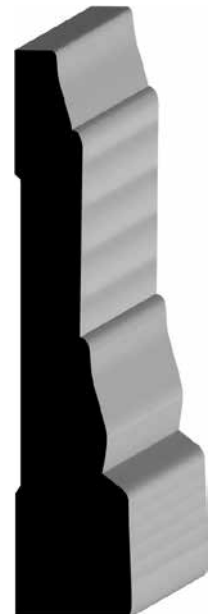

LWM332PN • 11/16" x 3-1/4"

All items priced per lineal foot • Specific lengths — add 15% • Specified 16' — add 25%

SOLID PINE

STOCKED PROFILES

CHAIR RAIL



WM390 • 11/16" x 2-5/8"

COVE

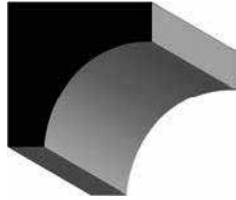

WM93 • 3/4" x 3/4"

PANEL



WM183 • 9/16" x 1-1/8"

SCREEN



WM142 • 1/4" x 3/4"

QUARTER ROUND



WM105 • 3/4" x 3/4"

STOP

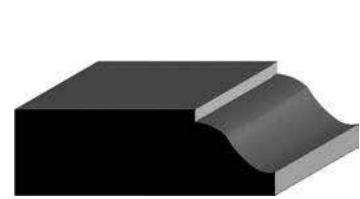

WM936 • 7/16" x 1-3/8"

CROWN

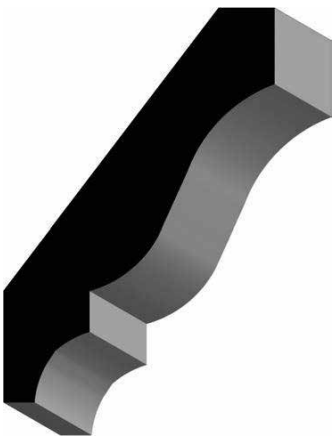

LWM49R • 9/16" x 3-5/8"

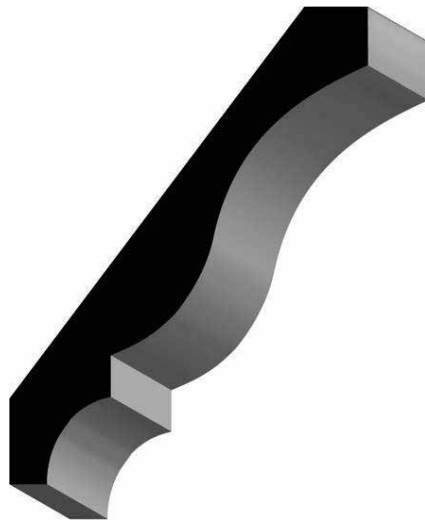

LWM48 • 9/16" x 4-1/4"

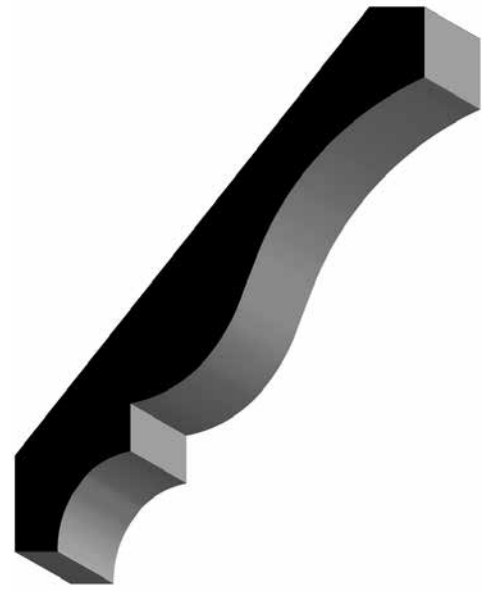

LWM47 • 11/16" x 5-1/4"

All items priced per lineal foot • Specific lengths — add 15% • Specified 16' — add 25%

DOWEL RODS

DIAMETERS

1/4", 3/8", 1/2",
3/4", 1", 1-1/4",
1-1/2", 1-3/4" and 2"

LENGTHS

3', 4', 5' and longer.

SPECIES

Cherry, Birch, Hard
Maple, Poplar, Red Oak,
Walnut and White Oak

HARDWOOD LUMBER S4S

*Sizes are stocked in Birch, Poplar, Red Oak, Hard Maple, Cherry and
Finger Jointed Primed Poplar. We also stock 1" thickness in Red Oak and Poplar.*

Also available in Red Oak and Poplar Only: 5/4 x 4" through 5/4 x 12"

CALL FOR MORE INFORMATION

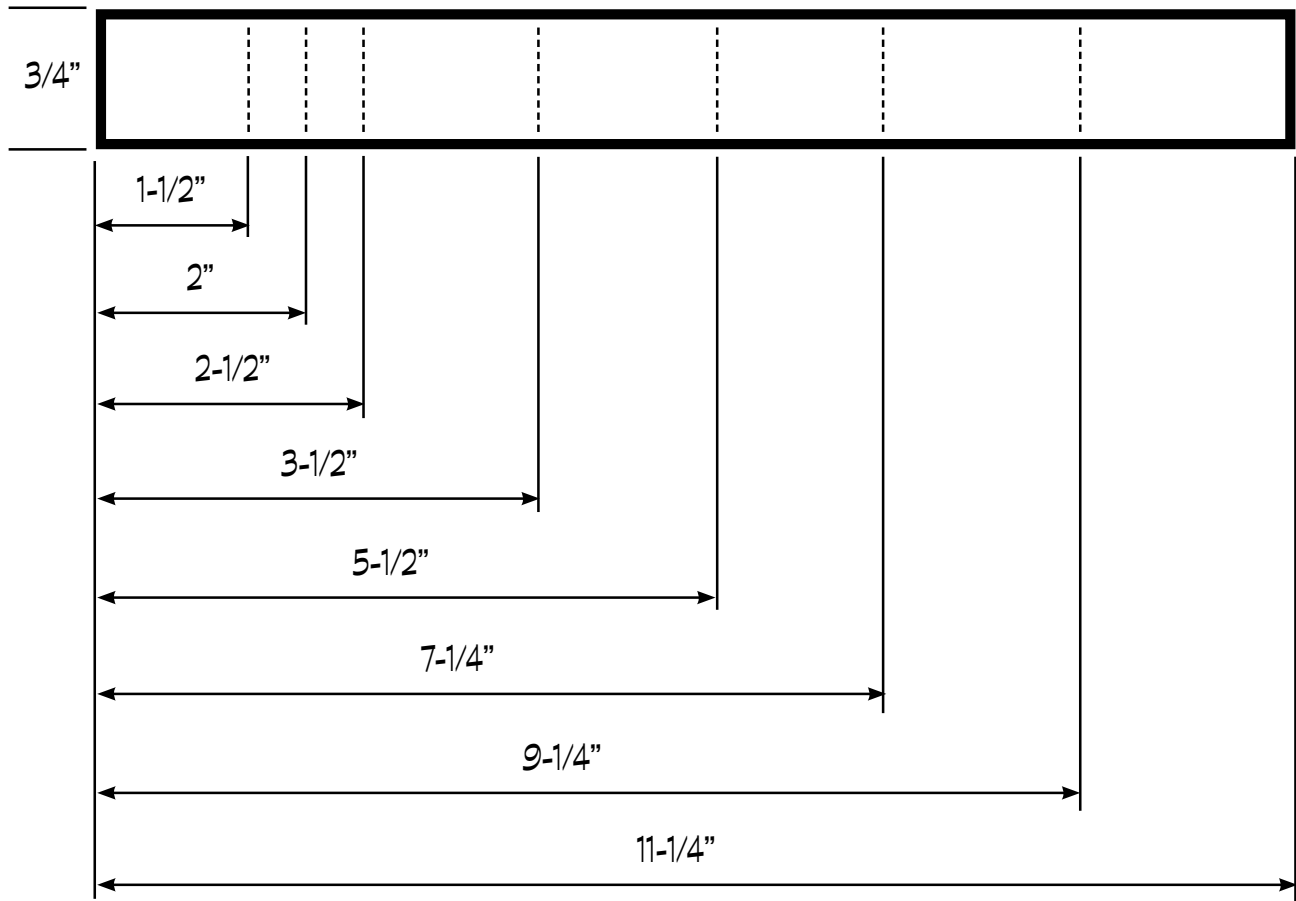
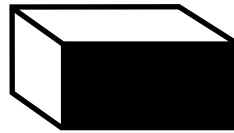

All items priced per lineal foot • Specific lengths — add 15% • Specified 16' — add 25%



S3S LUMBER

ALDER

4/4 S3S, SUPERIOR
4/4 S3S, RUSTIC

AROMATIC CEDAR

4/4 S3S

BASSWOOD

SELECT AND BETTER, ROUGH
4/4, 5/4, 6/4, 8/4, 10/4, 12/4,
16/4

BIRCH

SELECT AND BETTER,
KILN DRIED
1/4, 4/4, 5/4, 6/4, 8/4

CHERRY

SELECT AND BETTER,
KILN DRIED
1/4, 1/2, 4/4, 5/4, 6/4, 8/4

CYPRESS

SELECT AND BETTER,
KILN DRIED
4/4, 5/4, 6/4, 8/4

HARD MAPLE

SELECT AND BETTER,
KILN DRIED
1/4, 1/2, 4/4, 5/4, 6/4, 8/4

HICKORY

SELECT AND BETTER,
KILN DRIED
4/4 SHORTS, 4/4, 5/4, 8/4

POPLAR

FIRSTS AND SECONDS,
KILN DRIED
1/4, 1/2, 4/4, 5/4, 6/4, 8/4,
10/4, 12/4

RED OAK

FIRSTS AND SECONDS,
KILN DRIED
1/4, 1/2, 4/4 MINI SHORTS,
4/4 SHORTS, 4/4, 5/4, 6/4, 8/4

RED OAK QUARTER SAWN

FIRSTS AND SECONDS,
KILN DRIED
4/4, 8/4

SYCAMORE

4/4 SHORTS, 4/4

WALNUT

FIRST AND SECONDS,
KILN DRIED
1/4, 1/2, 4/4 SHORTS,
4/4, 5/4, 6/4, 8/4

WHITE OAK

FIRST AND SECONDS,
KILN DRIED
4/4 SHORTS, 4/4, 5/4, 6/4, 8/4

WHITE OAK QUARTER SAWN

S3S, KILN DRIED
4/4, 8/4

EXOTIC LUMBER

AFRICAN MAHOGANY

4/4, 5/4, 6/4, 8/4

BUBINGA

(AFRICAN ROSEWOOD)
4/4

LACEWOOD

4/4

MORADO

(BOLIVIAN ROSEWOOD)
4/4

PADUAK

4/4

PURPLE HEART

4/4

SPANISH CEDAR

1/4, 4/4

BURMESE TEAK

4/4, 8/4

WENGE

4/4

ZEBRA WOOD

4/4

RED GRANADILLO

4/4

SAPELE

4/4, 8/4

HARDWOOD PLYWOOD

We stock the following species and sizes of domestic plywood.

We also stock 1/4", 1/2" and 3/4" imported plywood in Birch, Red Oak, Poplar, Hard Maple, Cherry and Hickory.

ALDER

1/4" X 4' X 8'
3/4" X 4' X 8'

BIRCH

1/8" X 4' X 8'
1/4" X 4' X 8'
1/4" X 4' X 10'
1/2" X 4' X 8'
3/4" X 4' X 8'
3/4" X 4' X 10'

CHERRY

1/4" X 4' X 8'
1/2" X 4' X 8'
3/4" X 4' X 8'

HARD MAPLE

1/4" X 4' X 8'
1/2" X 4' X 8'
3/4" X 4' X 8'

HICKORY

1/4" X 4' X 8'
3/4" X 4' X 8'

MAHOGANY

1/4" X 4' X 8'
3/4" X 4' X 8'

KNOTTY ALDER

1/4" X 4' X 8'
3/4" X 4' X 8'

KNOTTY PINE

1/4" X 4' X 8'
3/4" X 4' X 8'

RED OAK

1/8" X 4' X 8'
1/4" X 4' X 8'
1/4" X 4' X 10'
1/2" X 4' X 8'
3/4" X 4' X 8'
3/4" X 4' X 10'

WALNUT

1/4" X 4' X 8'
3/4" X 4' X 8'

WHITE OAK

1/4" X 4' X 8'
3/4" X 4' X 8'

WHITE OAK QUARTER SAWN

1/4" X 4' X 8'
3/4" X 4' X 8'

1-1/2" BEADED PANEL

1/4" X 4' X 8' Red Oak
1/4" X 4' X 8' Birch

BALTIC BIRCH 5' X 5' & 30" X 5'

1/8", 1/4", 3/8", 1/2",
5/8", 3/4"

MARINE PLYWOOD

1/2" X 4' X 8'
3/4" X 4' X 8'

IMPORT BIRCH UV COATED

1/4" X 4' X 8' VC, UV 1 Side
1/2" X 4' X 8' VC, UV 1 or
2 Side
3/4" X 4' X 8' VC, UV 1 or
2 Side

MEDIUM DENSITY FIBERBOARD

1/4" X 4' X 8' MDF
1/2" X 4' X 8' MDF
3/4" X 4' X 8' MDF
3/4" X 4' X 10' MDF Upon
Request

SUPER LIGHT MDF

1/2" X 4' X 8' MDF
3/4" X 4' X 8' MDF
1" X 4' X 8' MDF

BENDING PLYWOOD

3/8" X 4' X 8' Luaun
Barrel Bend
3/8" X 4' X 8' Luaun
Canoe Bend

INTERIOR DOORS

We are a TruStile® interior door dealer. Please call for information and availability.

TRU[®]STILE



RADIUS MILLWORK

Many profiles are available. Please call for more information.

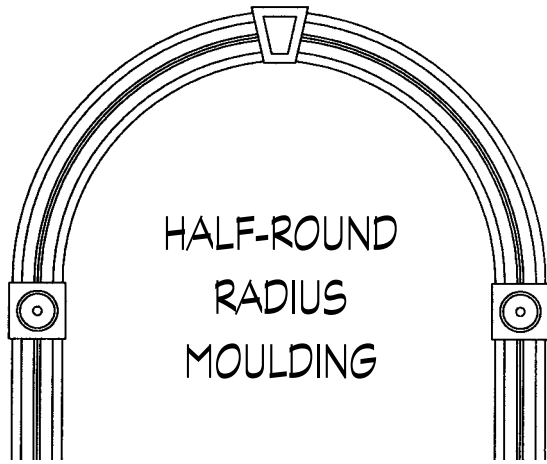

HALF-ROUND
RADIUS
MOULDING

MEASURING FOR MILLWORK

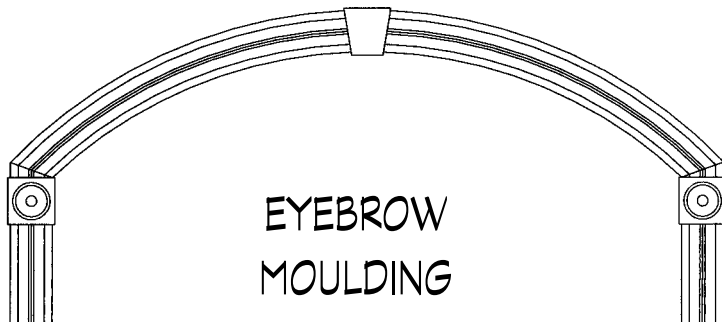
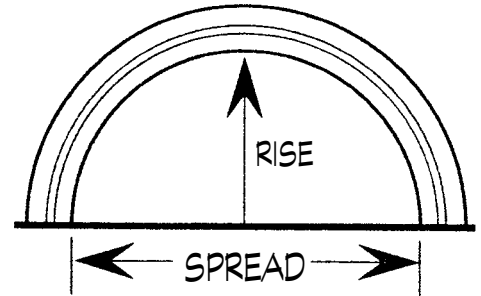

EYEBROW
MOULDING

RISE FROM CENTER

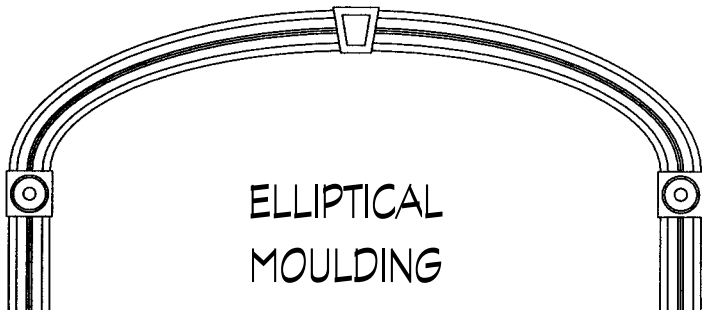
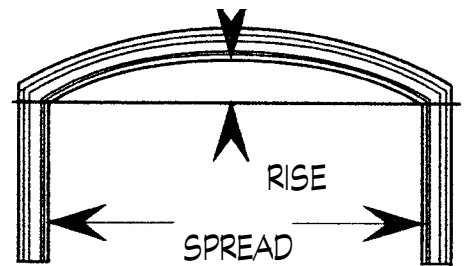

ELLIPTICAL
MOULDING



PAPER OR CARDBOARD
TEMPLATE NEEDED

STAIR PARTS

We stock WM Coffman wood and iron balusters and wood stair parts. Please call for availability.



FLEXIBLE MOULDING

Over 400 profiles are available in paint and stain grade patterns. Please call for more information.



FLEX TRIM



- ALL PARTS ARE PRIMED
- EXCELLENT FOR EXTERIORS
- CUTS AND MACHINES LIKE WOOD

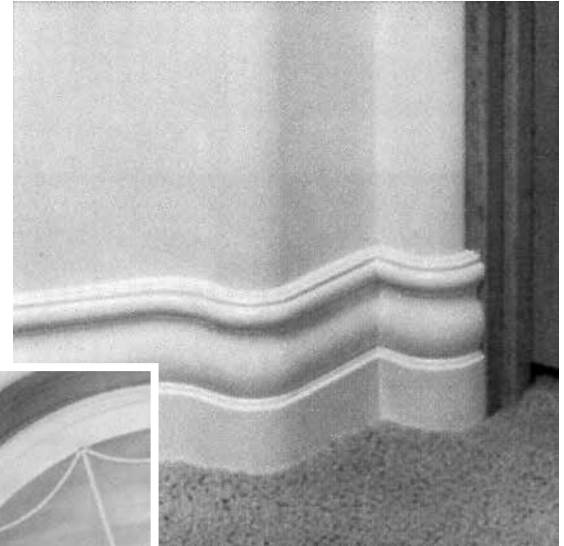

- NO SPECIAL ADHESIVES REQUIRED WHEN NAILED
- LESS EXPENSIVE THAN WOOD RADIUS AND CURVE PARTS



- GUARANTEED AGAINST SPLITTING, CRACKING OR BREAKING
- EASY TO INSTALL



- STRONGER WITH INCREASED FLEXIBILITY
- NAILS LIKE WOOD-NO PRE-DRILLING



PRODUCING THE PERFECT CURVE IS EASIER WITH ULTIMATE FLEX—THE ADVANCED POLYURETHANE PRODUCT.

FLEXIBLE MOULDING

Over 400 profiles are available in paint and stain grade patterns.
Mouldings below are in stock. Please call for more information.



FLEX TRIM

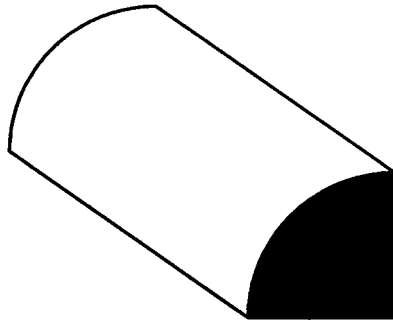

QUARTER ROUND

UF-301-P

UF-301-O

3/4" x 3/4" x 10'

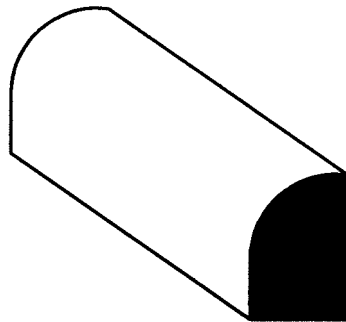

BASE SHOE

ER-126-P

ER-126-O

1/2" x 3/4" x 12'

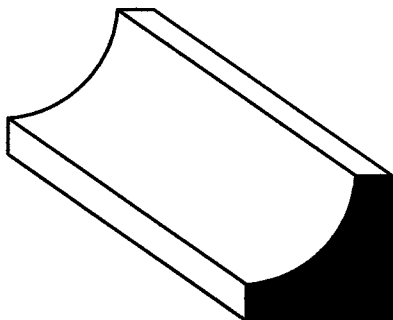

COVE MOULD

UF-253-P

3/4" x 3/4" x 10'

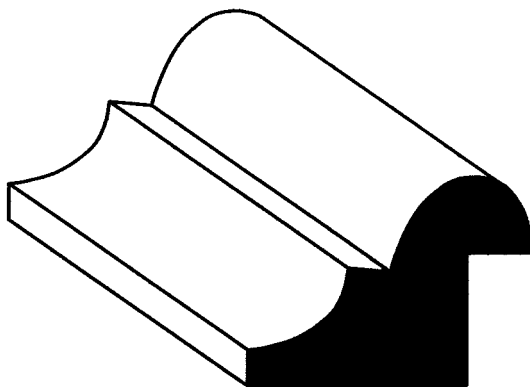

PANEL MOULD

MO-2662-P (STCH #84)

9/16" x 1-5/8" x 10'

ARCHITECTURAL COLUMNS

STAIN & PAINT GRADE

St. Charles Hardwoods offers a complete line of wood and fiberglass columns. Architectural columns are available in stain grade for interior use, or finger jointed for exterior use. Stock columns are made of finger jointed pine and available in round or square plain or fluted. Column shafts are manufactured with patented machinery to assure the highest quality product available. Stain grades are available in Mahogany, Red Oak, Hard Maple and Cherry.

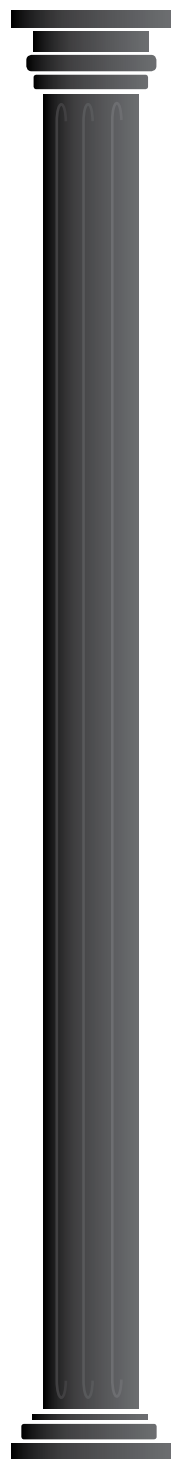

STAIN GRADE FOR INTERIOR USE OR FINGER JOINTED FOR EXTERIOR USE
ARCHITECTURAL SPECIFICATIONS (IN INCHES)

COLUMN SIZE	A	B	C	D	E	F	G	J	K	L	O	N	R	T
6	5 5/8	4 5/8	8 5/8	1 15/16	2	5/8	1 1/16	1 9/16	1 1/4	7 1/2	1/2	1/2	4 9/16	1 1/2
8	7 5/8	6 1/4	10 1/8	1 15/16	2	5/8	1 1/16	1 9/16	1 1/4	9 1/16	1/2	1/2	4 9/16	1 1/2
10	9 5/8	8	12 15/16	2 7/16	2 1/4	3/4	3/4	1 1/4	1 11/16	10 15/16	5/8	5/8	5 7/16	1 5/8
12	11 5/8	9 3/8	16	2 13/16	2 1/4	1	13/16	1 3/4	2	13 3/4	3/4	3/4	6 1/16	1 3/4
14	13 5/8	11 5/8	19 1/16	3 7/16	3 1/8	1	7/8	2 1/16	2 3/4	17 1/4	7/8	7/8	7 9/16	2 1/4
16	15 5/8	13 5/8	21 13/16	3 15/16	3 1/8	1	1	2 1/4	2 13/16	19 7/8	1	1	8 9/16	2 5/8
18	17 5/8	15 1/2	25 3/16	4 5/16	4 1/2	1 1/2	1 13/16	2 11/16	3	22 7/16	1 5/16	1 5/16	10 5/16	2 7/8
20	19 5/8	17 1/4	27 5/8	4 13/16	4 1/4	1 3/4	1 5/16	2 3/4	3 15/16	24 15/16	1 3/4	1 3/4	10 13/16	2 1/4
22	21 5/8	19 1/4	30 3/8	5 1/8	4 3/4	2 1/8	1 3/8	3	3 3/4	27 7/8	1 7/8	1 7/8	12	3 1/2
24	23 5/8	21 1/4	33 3/4	5 3/4	5 1/4	2 1/4	1 9/16	3 3/8	4 1/8	30 3/4	2	2	13 1/4	3 7/8
26	25 5/8	22 1/4	36 3/4	6 1/4	4 5/8	2 5/8	1 11/16	3 5/8	4 3/8	33	2	2	13 1/16	4 1/4
28	27 5/8	24 1/4	39	6 3/4	6	2 3/4	1 13/16	4	4 3/4	35 1/2	2	2	15 1/2	4 5/8
30	29 5/8	26 1/4	41 3/4	7 1/4	6 1/2	2 3/4	1 15/16	4	5 1/8	37 3/4	2	2	16 1/2	5

COLUMN INSIDE DIMENSIONS (IN INCHES)
INSIDE DIAMETER MAY VARY UP TO 1/4". SPLITTING A COLUMN WILL DECREASE INSIDE DIMENSIONS 1/8"

COLUMN SIZE	TOP I.D.	BOTTOM I.D.	COLUMN SIZE	TOP I.D.	BOTTOM I.D.
6	2 1/8	3 3/8	20	14 1/2	16 7/8
8	4	5 3/8	22	16 1/2	18 7/8
10	5 3/8	7 3/8	24	18 1/2	20 7/8
12	7 1/8	9 3/8	26	20	22 7/8
14	8 7/8	10 7/8	28	21 3/4	24 7/8
16	10 7/8	12 7/8	30	23 1/2	26 7/8
18	12 3/4	14 7/8			

ARCHITECTURAL & STOCK COLUMN LOAD BEARING SPECIFICATIONS

COLUMN SIZE	STRUCTURAL LOAD LIMITS-PER COLUMN	COLUMN SIZE	STRUCTURAL LOAD LIMITS-PER COLUMN
6	3,000	16	10,000
8	5,000	18	14,000
10	6,000	20	16,000
12	7,000	22-30	16,000
14	8,000		

SPLITTING OPTIONS

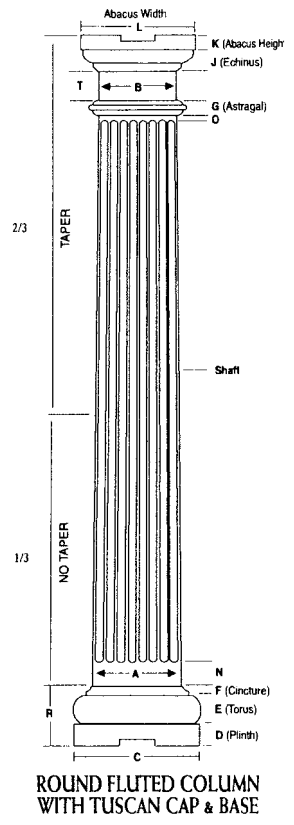

CORBELS & BAR BRACKETS

*Our corbels and bar brackets are crafted by Hardware Resources and White River.
Items shown are stocked in Rubberwood. Other species are available.
Other sizes and designs are available. Please call for more information and pricing.*

BAR BRACKETS



ACANTHUS BAR
BRACKET
CORE



CARVED BAR
BRACKET
CORS



TRADITIONAL
BAR BRACKET
CORF

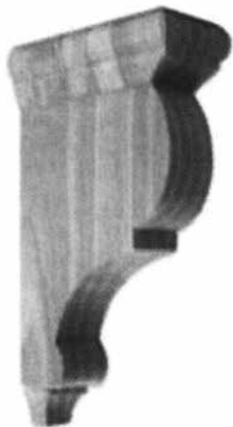

PLAIN BAR
BRACKET
CORG



PLAIN BAR
BRACKET
CORM-3



MISSION STYLE
BAR BRACKET
CORH

CORBELS & BAR BRACKETS

*Our corbels and bar brackets are crafted by Hardware Resources and White River.
Items shown are stocked in Rubberwood. Other species are available.
Other sizes and designs are available. Please call for more information and pricing.*

HAND CARVED CORBELS



SMALL
TRADITIONAL
CORC-1



SMALL
ROUND
CORQ-1



SMALL
ARTS & CRAFTS
CORX-1



SMALL
ACANTHUS
CORBB-1



LOW PROFILE
ACANTHUS
CORK-01



MISSION
STYLE
CORO-2



TRADITIONAL
ISLAND
FCORQ

CORBELS & BAR BRACKETS

*Our corbels and bar brackets are crafted by Hardware Resources and White River.
Items shown are stocked in Rubberwood. Other species are available.
Other sizes and designs are available. Please call for more information and pricing.*

BUNN, PEDESTAL & CLAW FEET



REVERSABLE
BF70

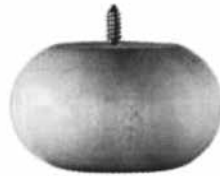

ROUNDED
BF30



TURNED
BF60

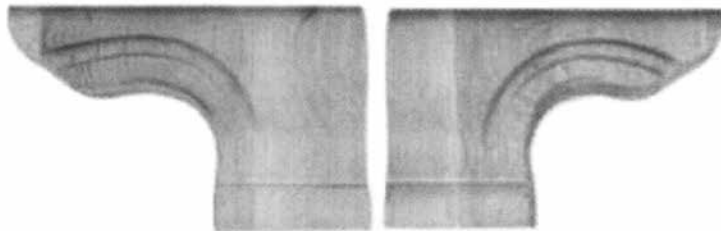

PEDESTAL
FOOT-RIGHT
PFR

PEDESTAL
FOOT-LEFT
PFL



BALL/CLAW LEG
WL60

CORBELS & BAR BRACKETS

*Our corbels and bar brackets are crafted by Hardware Resources and White River.
Items shown are stocked in Rubberwood. Other species are available.
Other sizes and designs are available. Please call for more information and pricing.*

TURNED POSTS & COLUMNS



TURNED
POST • P1



REED
POST • P2



ROPE
POST • P3



TAPERED
POST • P4



MISSION
POST • P9



MISSION
POST • P38



ACANTHUS
CORNER
CP-1



TRADITIONAL
POST
CP-3



FIREPLACE
POST
FP1



ONL-02-24



ONL-04-20



ONL-07-20

APPLIQUES

STOCKED DESIGNS

Please call for more information and pricing.



AC601
3-3/4" DIA.



AC602
2-1/4" x 1-3/4"



AC614
5-1/4" x 9-1/4"



AC615
5-1/4" x 10-5/8"



AC620 • 5" x 2-3/8"



AC605
3-1/8" x 1-3/8"



AC606
3-3/8" x 2-1/2"



AC616
6-1/8" x 11-1/2"



AC623
3/4" x 6-1/4"



AC621 • 7" x 2-3/4"



AC622 • 5-7/8" x 3-1/4"



AC607
3-3/4" x 4"



AC609
5-1/8" DIA.



AC618 • 7-1/2" x 2"



AC624 • 5-7/8" x 3-1/4"



AC610 • 7" x 4"



AC619 • 5-1/2" x 2"



AC625 • 4-1/2" x 2-1/2"



AC627 • 5-1/8" x 2-1/2"



AC629 • 7-1/4" x 1-5/8"



AC626 • 5-1/8" x 3-1/4"

APPLIQUES

STOCKED DESIGNS

Please call for more information and pricing.



AC632
1-3/8" DIA.



AC633
1-1/2" DIA.



AC649 • 5-1/8" x 1-1/4"



AC651 • 6-3/4" x 1-3/4"



AC634
1-1/2" DIA.



AC635
1-3/4" x 1-3/4"



AC653 • 10-1/4" x 2-1/2"



AC655 • 12-1/8" x 2-1/4"



AC637
7/8" x 1-1/2"



AC638
1-1/2" x 2-3/8"



AC657 • 17-1/2" x 2"



AC665 • 11-1/4" x 5-3/4"



AC641
1-3/8" x 3-3/4"



AC669
1-1/2" DIA.



AC663 • 5-3/4" x 8-3/4"

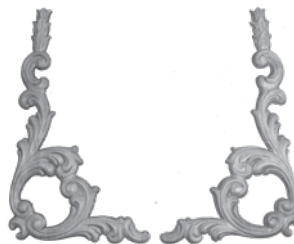

AC667 • 11" x 6-1/8"



AC659
3-3/8" x 25-1/4"

APPLIQUÉS

STOCKED DESIGNS

Please call for more information and pricing.



AC670
1" x 1-3/8"



AC672
1-7/8" x 1-7/8"



AC674
1-1/4" x 2-3/4"



AC676
1-7/8" x 2-1/4"



AC677 • 3" DIA.



AC678 • 4-1/2" x 2-1/2"



AC679 • 3-1/4" x 3-1/2"



AC684 • 4" x 2-3/4"



AC686 • 4-3/4" x 3-3/8"



AC687 • 4" x 5-3/4"



AC688 • 6-3/8" x 4-3/4"



AC697 • 16-3/8" x 9-7/8"



AC703 • 22-1/2" x 3-1/2"



AC705 • 29" x 4-1/2"



AC706 • 16" x 7-1/2"



AC708 • 18" x 6-1/2"



AC710 • 7-3/4" x 2"



AC714 • 12-3/8" x 3"



AC716 • 13-3/8" x 2-1/2"



AC718 • 16" x 2-3/4"



AC725 • 21-5/8" x 6-7/8"

APPLIQUÉS

STOCKED DESIGNS

Please call for more information and pricing.



AC727 • 36-7/8" x 5-5/8"



AC728 • 35-1/2" x 7"



AC730 • 53-3/4" x 10-3/8"



AC731
5-7/8" x 6-3/8"



AC733
8-3/8" x 3-1/2"



AC738
9-1/2" x 4-1/4"



AC760 • 6-3/8" x 8"



AC741
9-1/4" x 14-1/4"



AC743
9-5/8" x 14-3/4"



AC766 • 7-7/8" x 1-3/8"



ACT70 • 9-7/8" x 4-3/8"



AC788 • 4-1/8" x 15-3/4"



AC783 • 10-7/8" x 2"



AC789 • 16-1/4" x 3-3/4"



AC790 • 16-1/4" x 2-1/2"



AC791 • 16-1/2" x 1-1/4"



AC792 • 17-1/2" x 2-1/2"

BAR FITTINGS

BRASS, POLISHED & SATIN STAINLESS STEEL

Please call for more information and pricing.



2" TUBING

- 00-A120 BRASS
- 44-A120 SATIN STAINLESS
- 40-A120 POLISHED STAINLESS



FLAT END CAP

- 00-600/2 BRASS
- 44-600/2 SATIN STAINLESS
- 40-600/2 POLISHED STAINLESS



COMBO BRACKET

- 00-400/2 BRASS
- 44-400/2 SATIN STAINLESS
- 40-400/2 POLISHED STAINLESS



DOMED END CAP

- 00-602/2 BRASS
- 44-602/2 SATIN STAINLESS
- 40-602/2 POLISHED STAINLESS



BAR BRACKET

- 00-402/2 BRASS
- 44-402/2 SATIN STAINLESS
- 40-402/2 POLISHED STAINLESS



2" BALL FINIAL

- 00-604/2 BRASS
- 44-604/2 SATIN STAINLESS
- 40-604/2 POLISHED STAINLESS



FLOOR FLANGE

- 00-404/2 BRASS



90° FLUSH ELBOW

- 00-732/2 BRASS
- 44-732/2 SATIN STAINLESS
- 40-732/2 POLISHED STAINLESS



WALL FLANGE

- 00-532/2 BRASS
- 44-532/2 SATIN STAINLESS
- 40-532/2 POLISHED STAINLESS

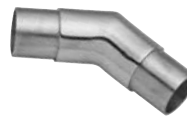

135° FLUSH ANGLE

- 00-730/2 BRASS
- 44-730/2 SATIN STAINLESS
- 40-730/2 POLISHED STAINLESS

BUTCHER BLOCK COUNTER TOPS

*St. Charles Hardwoods makes custom butcher blocks to order.
Many sizes and species are available. Please call for more information and prices.*





CUSTOMIZE IT!

SKETCH OUT YOUR CUSTOM PROFILE

Please call for more information and pricing. Grid: 1/4" = 1"

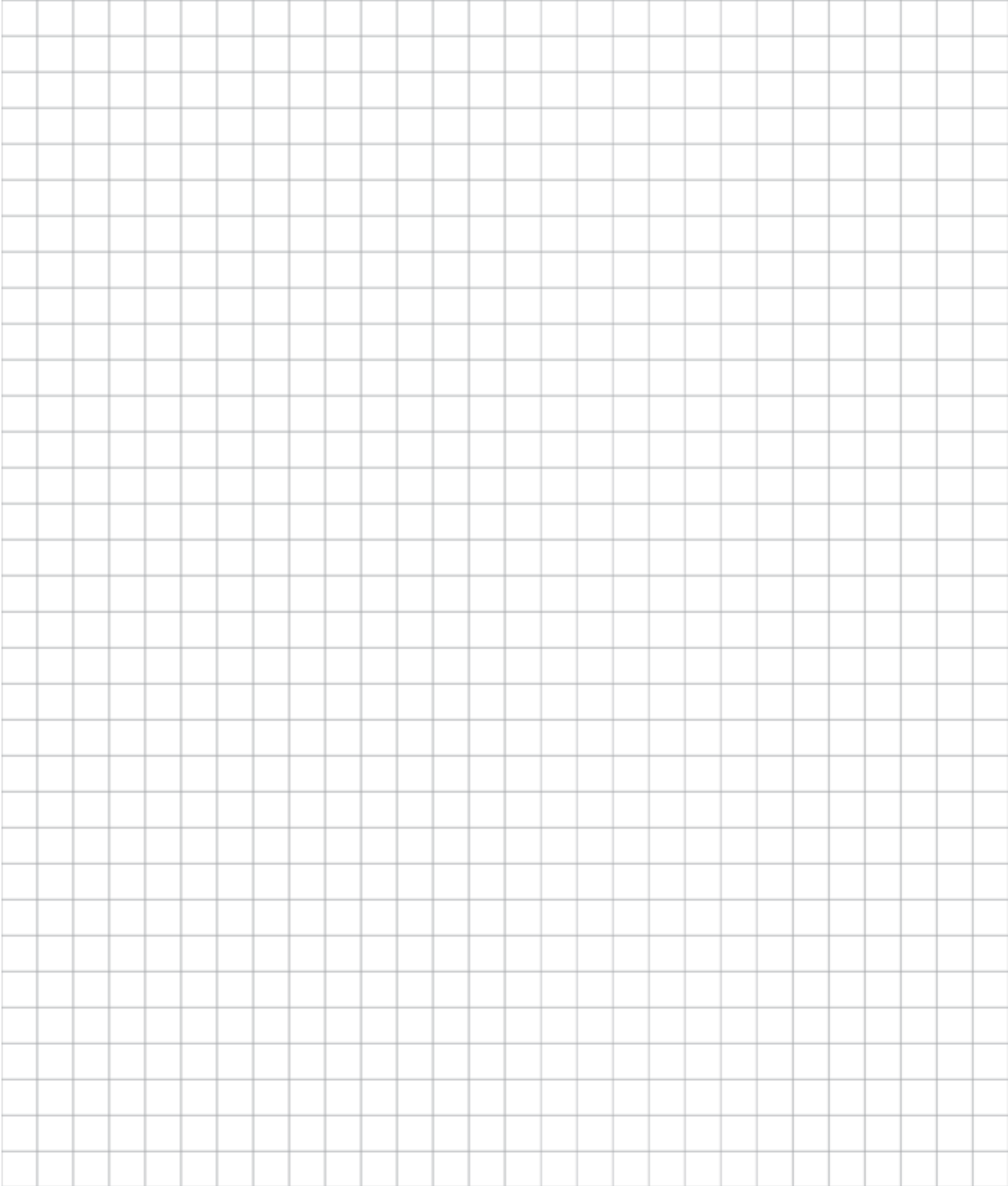



CUSTOMIZE IT!

SKETCH OUT YOUR CUSTOM PROFILE

Please call for more information and pricing. Grid: 1/4" = 1"

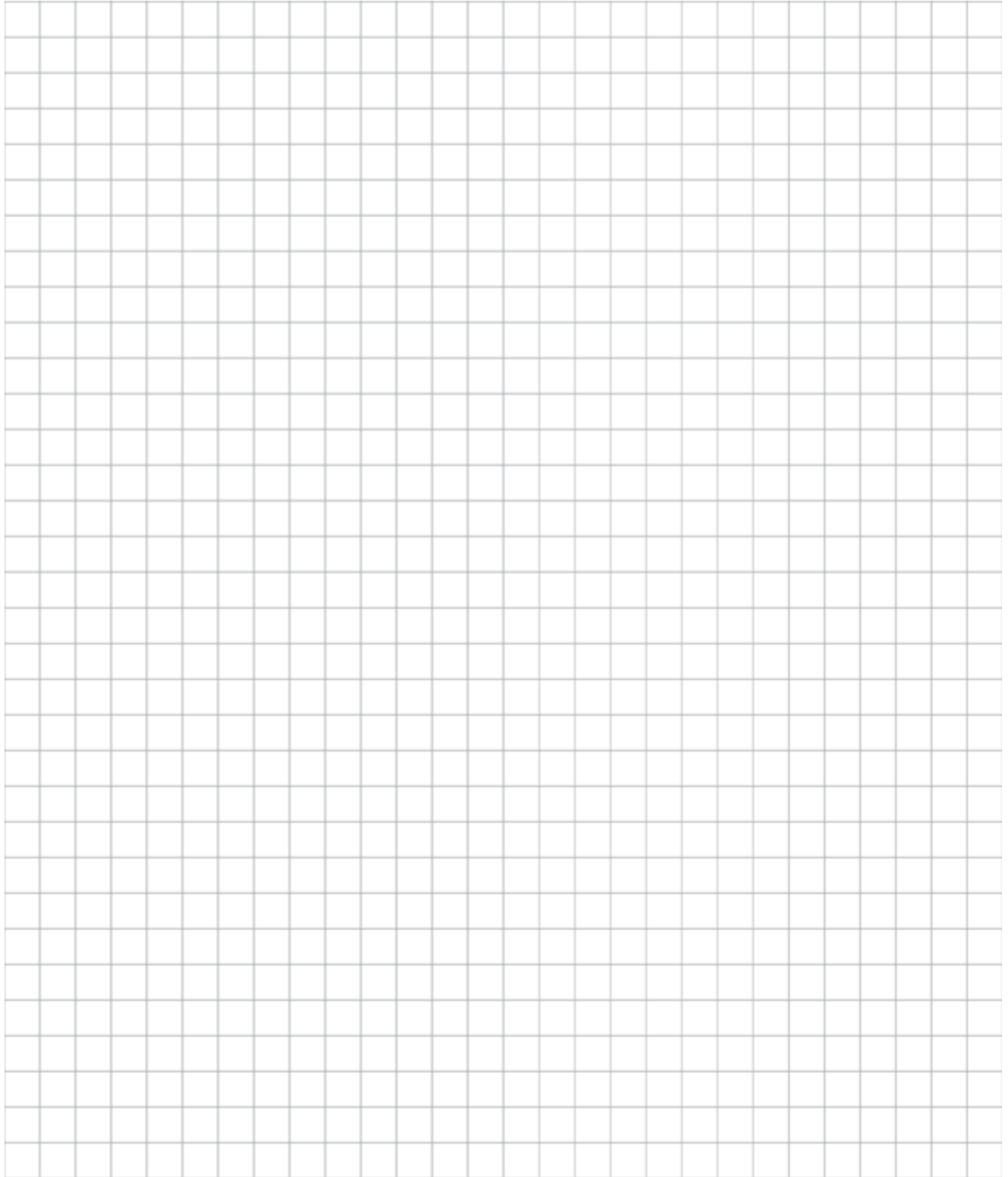

WE HAVE IT ALL!

STOCKED DESIGNS

We proudly sell many other items with the woodworker in mind.

Below are the names of many popular manufactures you will find at St. Charles Hardwoods.

INTERIOR DOORS & MILLWORK PRODUCTS



PLYWOOD & VENEER PRODUCTS



WOOD STAIR PARTS & IRON STAIR PARTS



ROUTER BITS, SAW BLADES, POWER TOOLS & ACCESSORIES



WOOD ADHESIVES



PAINTS/WOOD STAIN PRODUCTS



BAR FIXTURES & ACCESSORIES



SEE PG. 66